



INSTRUCTION MANUAL

VHF MARINE TRANSCEIVER IC-M421



Icom Inc.

FOREWORD

Thank you for purchasing this Icom product. The IC-M421 VHF MARINE TRANSCEIVER is designed and built with Icom's state of the art technology and craftsmanship. With proper care, this product should provide you with years of trouble-free operation.

We want to take a couple of moments of your time to thank you for making the IC-M421 your radio of choice, and hope you agree with Icom's philosophy of "technology first." Many hours of research and development went into the design of your IC-M421.

◇ **FEATURES**

- *Built-in DSC meets ITU Class D requirement*
- *Superior receiver performance*
- *Large 2-digit Ch with scrolling channel comment*
- *Rugged waterproof construction*
- *Easy to hear speaker*

Icom, Icom Inc. and the ICOM logo are registered trademarks of Icom Incorporated (Japan) in the United States, the United Kingdom, Germany, France, Spain, Russia and/or other countries.

IMPORTANT

READ ALL INSTRUCTIONS carefully and completely before using the transceiver.

SAVE THIS INSTRUCTION MANUAL — This instruction manual contains important operating instructions for the IC-M421.

EXPLICIT DEFINITIONS

| WORD | DEFINITION |
|------------------|---|
| ⚠ WARNING | Personal injury, fire hazard or electric shock may occur. |
| CAUTION | Equipment damage may occur. |
| NOTE | If disregarded, inconvenience only. No risk of personal injury, fire or electric shock. |

CLEAN THE TRANSCEIVER AND MICROPHONE THOROUGHLY WITH FRESH WATER after exposure to water including salt water, otherwise, the keys and switches may become inoperable due to salt crystallization.

IN CASE OF EMERGENCY

If your vessel requires assistance, contact other vessels and the Coast Guard by sending a distress call on Channel 16.

USING CHANNEL 16

DISTRESS CALL PROCEDURE

1. "MAYDAY MAYDAY MAYDAY."
2. "THIS IS" (name of vessel)
3. Your call sign or other indication of the vessel (AND 9-digit DSC ID if you have one).
4. "LOCATED AT" (your position)
5. The nature of the distress and assistance required.
6. Any other information which might facilitate the rescue.

Or, transmit your distress call using digital selective calling on Channel 70.

USING DIGITAL SELECTIVE CALLING (Ch 70)

DISTRESS CALL PROCEDURE

1. While lifting up the key cover, push and hold **[DISTRESS]** for 5 sec. until you hear 5 short beeps change to one long beep.
2. Wait for an acknowledgment on Channel 70 from a coast station.
 - After the acknowledgment is received, Channel 16 is automatically selected.
3. Push and hold **[PTT]**, then transmit the appropriate information as listed above.

INSTALLATION NOTE

The installation of this equipment should be made in such a manner as to respect the EC recommended electromagnetic field exposure limits (1999/519/EC).

The maximum RF power available from this device is 25 watts. The antenna should be installed as high as possible for maximum efficiency and that this installation height should be at least 5 meters above ground (or accessible) level. In the case where an antenna cannot be installed at a reasonable height, then the transmitter should neither be continuously operated for long periods if any person is within 5 meters of the antenna, nor operated at all if any person is touching the antenna.

In all cases any possible risk depends on the transmitter being activated for long periods. (actual recommendation limits are specified as an average of 6 minutes) Normally the transmitter is not active for long periods of time. Some radio licenses will require that a timer circuit automatically cuts the transmitter after 1–2 minutes etc.

Similarly some types of transmitter, SSB, CW, AM, etc. have a lower 'average' output power and the perceived risk is even lower.

DOC



CE versions of the IC-M421 which display the "CE" symbol on the serial number seal, comply with the essential requirements of the European Radio and Telecommunication Terminal Directive 1999/5/EC.



This warning symbol indicates that this equipment operates in non-harmonised frequency bands and/or may be subject to licensing conditions in the country of use. Be sure to check that you have the correct version of this radio or the correct programming of this radio, to comply with national licensing requirement.



We Icom Inc. Japan
1-1-32, Kamiminami, Hirano-ku
Osaka 547-0003, Japan

Declare on our sole responsibility that this equipment complies with the essential requirements of the Radio and Telecommunications Terminal Equipment Directive, 1999/5/EC, and that any applicable Essential Test Suite measurements have been performed.

Kind of equipment: VHF MARINE TRANSCEIVER

Type-designation: IC-M421

Version (where applicable):

This compliances is based on conformity with the following harmonised standards, specifications or documents:

| | |
|-------------------------|------------------------------|
| i) <u>EN 301 025-2</u> | <u>V1.2.1 (2004-01)</u> |
| ii) <u>EN 301 025-3</u> | <u>V1.2.1 (2004-01)</u> |
| iii) <u>EN 60945</u> | <u>1997</u> |
| iv) <u>EN 60950</u> | <u>August 1992, A11 1997</u> |
| v) <u>EN 300 698-2</u> | <u>V1.1.1 (2000-08)</u> |
| vi) <u>EN 300 698-3</u> | <u>V1.1.1 (2001-05)</u> |

DECLARATION OF CONFORMITY

CE0560

Düsseldorf 21th Jul. 2004
Place and date of issue

Icom (Europe) GmbH
Himmelgeisterstraße 100
D-40225 Düsseldorf

Authorized representative name

H. Ikegami
General Manager

Signature

Icom Inc.

TABLE OF CONTENTS

| | | | |
|------------------------------------|--------------|--|--------------|
| FOREWORD | i | 6 DSC OPERATION | 14–44 |
| IMPORTANT | i | ■ MMSI code programming | 14 |
| EXPLICIT DEFINITIONS | i | ■ MMSI code check | 15 |
| IN CASE OF EMERGENCY | ii | ■ DSC individual ID | 16 |
| INSTALLATION NOTE | ii | ■ Position and time programming | 20 |
| DOC | iii | ■ Position and time indication | 21 |
| TABLE OF CONTENTS | iv | ■ Distress call | 22 |
| PRECAUTION | v | ■ Transmitting DSC calls | 25 |
| 1 OPERATING RULES | 1 | ■ Receiving DSC calls | 37 |
| 2 PANEL DESCRIPTION | 2–5 | ■ Received messages | 41 |
| ■ Panel description | 2 | ■ DSC Set mode | 43 |
| ■ Function display | 4 | 7 SET MODE | 45–46 |
| ■ Microphone | 5 | ■ Set mode programming | 45 |
| 3 BASIC OPERATION | 6–10 | ■ Set mode items | 45 |
| ■ Channel selection | 6 | 8 CONNECTIONS AND MAINTENANCE | 47–50 |
| ■ Receiving and transmitting | 8 | ■ Supplied accessories | 47 |
| ■ Call channel programming | 9 | ■ Antenna | 47 |
| ■ Channel comments | 10 | ■ Fuse replacement | 47 |
| ■ Microphone lock function | 10 | ■ Cleaning | 47 |
| ■ Display backlighting | 10 | ■ Connections | 48 |
| 4 DUALWATCH/TRI-WATCH | 11 | ■ Mounting the transceiver | 49 |
| ■ Description | 11 | ■ Optional MB-69 installation | 50 |
| ■ Operation | 11 | 9 TROUBLESHOOTING | 51 |
| 5 SCAN OPERATION | 12–13 | 10 CHANNEL LIST | 52–53 |
| ■ Scan types | 12 | 11 SPECIFICATIONS AND OPTION | 54 |
| ■ Setting tag channels | 13 | ■ Specifications | 54 |
| ■ Starting a scan | 13 | ■ Option | 54 |
| | | 12 TEMPLATE | 55 |
| | | DIMENSIONS | 57 |

PRECAUTION

⚠ WARNING! NEVER connect the transceiver to an AC outlet. This may pose a fire hazard or result in an electric shock.

NEVER connect the transceiver to a power source of more than 16 V DC or use reverse polarity. This will ruin the transceiver.

NEVER cut the DC power cable between the DC plug and fuse holder. If an incorrect connection is made after cutting, the transceiver may be damaged.

NEVER place the transceiver where normal operation of the vessel may be hindered or where it could cause bodily injury.

KEEP the transceiver at least 1 m away from the ship's navigation compass.

DO NOT use or place the transceiver in areas with temperatures below -20°C or above $+60^{\circ}\text{C}$ or in areas subject to direct sunlight, such as the dashboard.

AVOID the use of chemical agents such as benzine or alcohol when cleaning, as they may damage the transceiver surfaces.

BE CAREFUL! The transceiver rear panel will become hot when operating continuously for long periods.

Place the transceiver in a secure place to avoid inadvertent use by children.

BE CAREFUL! The transceiver, HM-150 employs waterproof construction, which corresponds to JIS waterproof specification, Grade 7 (1 m/30 min.). However, once the transceiver or microphone has been dropped, waterproofing cannot be guaranteed due to the fact that the case may be cracked, or the waterproof seal damaged, etc.

◇ PRIORITIES

- Read all rules and regulations pertaining to priorities and keep an up-to-date copy handy. Safety and distress calls take priority over all others.
- You must monitor Channel 16 when you are not operating on another channel.
- False or fraudulent distress signals are prohibited and punishable by law.

◇ PRIVACY

- Information overheard but not intended for you cannot lawfully be used in any way.
- Indecent or profane language is prohibited.

◇ RADIO LICENSES

(1) SHIP STATION LICENSE

You must have a current radio station license before using the transceiver. It is unlawful to operate a ship station which is not licensed.

Inquire through your dealer or the appropriate government agency for a Ship-Radiotelephone license application. This government-issued license states the call sign which is your craft's identification for radio purposes.

(2) OPERATOR'S LICENSE

A Restricted Radiotelephone Operator Permit is the license most often held by small vessel radio operators when a radio is not required for safety purposes.

The Restricted Radiotelephone Operator Permit must be posted or kept with the operator. Only a licensed radio operator may operate a transceiver.

However, non-licensed individuals may talk over a transceiver if a licensed operator starts, supervises, ends the call and makes the necessary log entries.

Keep a copy of the current government rules and regulations handy.

■ Panel description

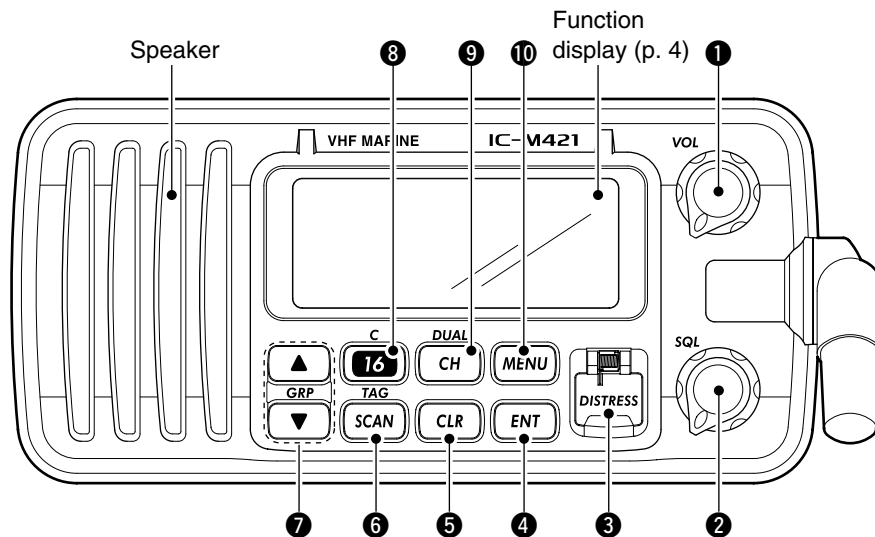

❶ POWER/VOLUME CONTROL [VOL] (p. 8)

- ➔ Rotate to turn the transceiver power ON or OFF.
- ➔ Rotate to adjust the audio level.

❷ SQUELCH CONTROL [SQL] (p. 8)

- Rotate to set the squelch threshold level.

❸ DISTRESS KEY [DISTRESS] (p. 22)

- Transmits a distress call when pushed for 5 sec.

❹ ENTER KEY [ENT]

- Sets the DSC menu, a channel comment, etc. when pushed.

❺ CLEAR KEY [CLR]

- Cancels the entered function and exits the condition when pushed.

6 SCAN/TAG CHANNEL KEY [SCAN•TAG] (p. 13)

- Push to start and stop the normal or priority scan when tag channels are programmed.
- Push for 1 sec. to set the displayed channel as a tag (scanned) channel.
- While pushing [**HI/LO**] located on the microphone, push for 3 sec. to clear or set all tag channels in the selected channel group.

7 CHANNEL UP/DOWN KEYS [▲]/[▼]•[U/I]

- Selects the operating channels, Set mode settings, etc. when pushed. (pgs. 6, 45)
- Selects one of two channel groups in sequence when both keys are pushed. (p. 7)
 - International and U.S.A.* channels are available. (*U.K. version only)
- While pushing [**SCAN•TAG**], push to adjust the brightness of the LCD and key backlight. (p. 10)

8 CHANNEL 16/CALL CHANNEL KEY [16•C]

- Selects Channel 16 when pushed. (p. 6)
- Selects call channel when pushed for 1 sec. (p. 6)
- Push for 3 sec. to enter the call channel programming condition when the call channel is selected. (p. 9)
- While pushing [**CH•DUAL**], push to enter the channel comment programming condition. (p. 10)
- While turning power ON, push to enter set mode. (p. 45)

9 CHANNEL/DUALWATCH/TRI-WATCH KEY [CH•DUAL]

- Push to select the regular channel. (pgs. 6, 7)
- Push for 1 sec. to start dualwatch or tri-watch. (p. 11)
- Push to stop dualwatch or tri-watch when either is activated. (p. 11)

10 DSC MENU KEY [MENU] (p. 14)

- Toggles the DSC menu ON or OFF when pushed.

■ Function display

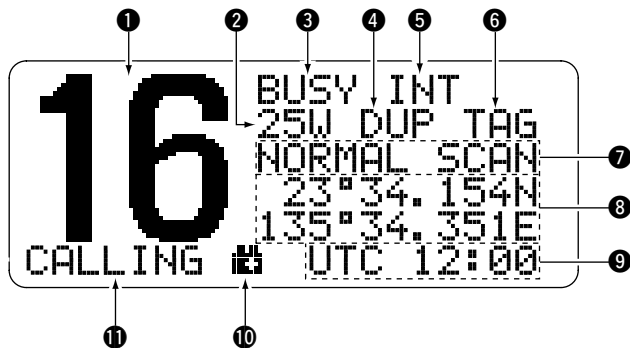

① CHANNEL NUMBER READOUT

Indicates the selected operating channel number.
 • “A” appears when a simplex channel is selected. (p. 7)

② POWER INDICATOR (p. 8)

- “25W” appears when high power is selected.
- “1W” appears when low power is selected.

③ BUSY/TRANSMIT INDICATOR (p. 8)

- “BUSY” appears when receiving a signal or when the squelch opens.
- “Tx” appears while transmitting.

④ DUPLEX INDICATOR (p. 7)

Appears when a duplex channel is selected.
 • Duplex channel has a different transmit frequency and receiving frequency.

⑤ CHANNEL GROUP INDICATOR (p. 7)

Indicates whether an International “INT” or U.S.A. “USA” channel is selected. (depends on version)

⑥ TAG CHANNEL INDICATOR (p. 13)

Appears when a tag channel is selected.

⑦ SCAN INDICATOR

- Either “NORMAL SCAN” or “PRI-SCAN 16” scan type appears while scanning. (p. 13)
- “DUAL 16” appears during dualwatch; “TRI 16” appears during tri-watch. (p. 11)

⑧ POSITION INDICATOR

- Shows the GPS position data.
 - “??” may blink every 2 sec. instead of position data; when the GPS position data is invalid. In such a case, the last position data is held for up to 23.5 hours.
 - “??” may blink every 2 sec. instead of position data 4 hours after the position data is input manually, up until 23.5 hours have past.
 - A beep sounds automatically for 1 min. every 4 hours when the GPS or manually input position data has not been updated.
- “No Position” appears when no GPS receiver is connected and no position data is input manually.

9 TIME ZONE INDICATOR

- Shows the current time data when a GPS receiver is connected.
- “No Time” appears when no GPS receiver is connected and no time data is input manually.
- “Local” appears when the offset time data is set. (p. 43)

10 LOW BATTERY INDICATOR

“” blinks when the battery voltage drops to approx. 11 V DC or below.

11 CHANNEL COMMENT INDICATOR

- Channel comment appears if programmed. (p. 10)
- More than 9-character comment scrolls automatically.

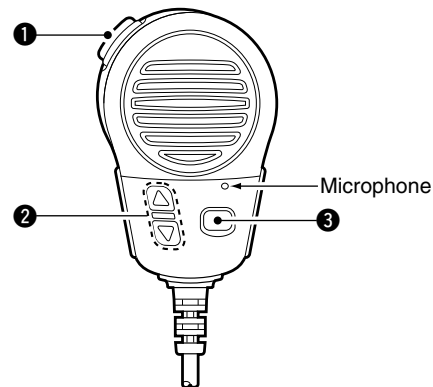
Microphone**1 PTT SWITCH [PTT]**

Push and hold to transmit; release to receive. (p. 8)

2 CHANNEL UP/DOWN KEYS [Δ]/[▽]

Push either key to change the operating memory channel, set mode settings, etc. (pgs. 6, 45)

3 TRANSMIT POWER KEY [HI/LO]

- Toggles power high and lower when pushed. (p. 8)
 - Some channels are set to low power only.
- While pushing [HI/LO], turn power ON to toggle the microphone lock function ON and OFF. (p. 10)

■ Channel selection

◇ Channel 16

Channel 16 is the distress and safety channel. It is used for establishing initial contact with another station and for emergency communications. Channel 16 is monitored during both dualwatch and tri-watch. While standing by, you must monitor Channel 16.

- Push [**16•C**] momentarily to select Channel 16.
- Push [**CH•DUAL**] to return to the condition before selecting Channel 16, or push [**▲**] or [**▼**] to select operating channel.

Push 

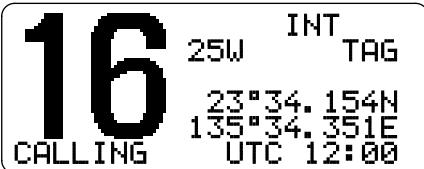

16 25W INT TAG
CALLING 23°34.154N
135°34.351E
UTC 12:00

◇ Call channel

Each regular channel group has a separate leisure-use call channel. The call channel is monitored during tri-watch. The call channels can be programmed (p. 9) and are used to store your most often used channels in each channel group for quick recall.

- Push [**16•C**] for 1 sec. to select the call channel of the selected channel group.
 - The call channel number appears.
 - Each channel group may have an independent call channel after programming a call channel.
- Push [**CH•DUAL**] to return to the condition before selecting the call channel, or push [**▲**] or [**▼**] to select an operating channel.

Push 
for 1 sec.

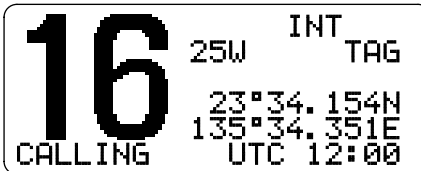

16 25W INT TAG
CALLING 23°34.154N
135°34.351E
UTC 12:00

◆ International channels and U.S.A. channels*

The IC-M421 is pre-programmed with 57 International (INT) channels in addition to 59 U.S.A. channels*. These channel groups may be specified for the operating area.

- ① Push [CH•DUAL] to select a regular channel.
- ② Push both [▲] and [▼] on the transceiver to change the channel group, if necessary.
 - International and U.S.A.* channels can be selected in sequence.
- ③ Push [▲] or [▼] to select a channel.
 - “DUP” appears for duplex channels.
 - “A” appears when a simplex channel is selected.

*U.K. version only

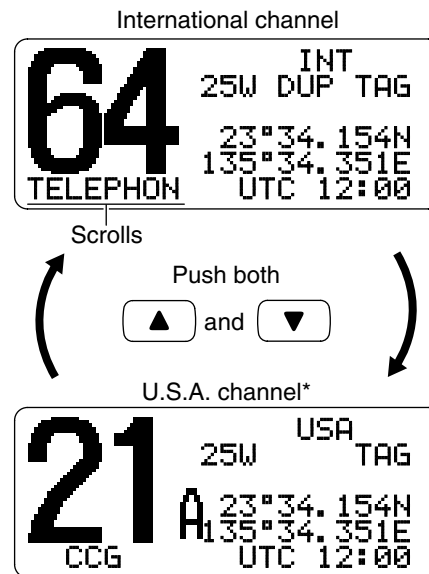

3 BASIC OPERATION

■ Receiving and transmitting

CAUTION: Transmitting without an antenna may damage the transceiver.

- ① Rotate **[VOL]** to turn power ON.
- ② Set the audio and squelch levels.
 - ➔ Rotate **[SQL]** fully counterclockwise in advance.
 - ➔ Rotate **[VOL]** to adjust the audio output level.
 - ➔ Rotate **[SQL]** clockwise until the noise disappears.
- ③ To change the channel group, push both **[▲]** and **[▼]** on the transceiver. (p. 7)
- ④ Push **[▲]** or **[▼]** to select the desired channel. (pgs. 6, 7)
 - When receiving a signal, “BUSY” appears and audio is emitted from the speaker.
 - Further adjustment of **[VOL]** may be necessary at this point.
- ⑤ Push **[HI/LO]** on the microphone to select the output power if necessary.
 - “25W” or “1W” appears when high or low power is selected, respectively.
 - Choose low power for short range communications, and choose high power for longer distance communications.
 - Some channels are for low power only.
- ⑥ Push and hold **[PTT]** to transmit, then speak into the microphone (*).
 - “TX” appears.
 - Channel 70 cannot be used for transmission other than DSC.
- ⑦ Release **[PTT]** to receive.

IMPORTANT: To maximize the readability of your transmitted signal, pause a few sec. after pushing **[PTT]**, hold the microphone (*) 5 to 10 cm from your mouth and speak at a normal voice level.

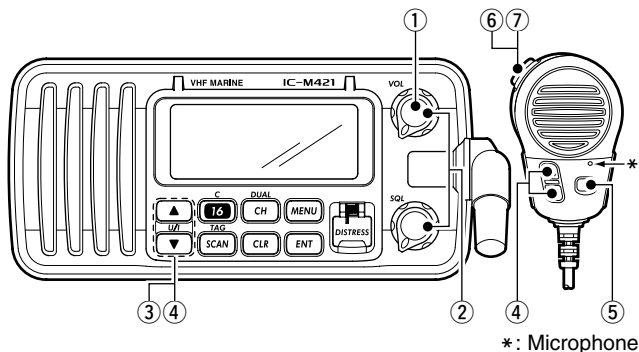

✓ NOTE for TOT (Time-out Timer) function

The TOT function inhibits continuous transmission over a pre-set time period after the transmission starts. A beep sounds 10 sec. before the TOT function activates, to indicate the transmission will be shut down and “TOT” appears on the channel comment indicator. Transmission is not possible for 10 sec. after this transmission shut down.

■ Call channel programming

You can program the call channel with your most often-used channel in each channel group for quick recall.

- ① Push both [▲] and [▼] on the transceiver to select the desired channel group (International and U.S.A.*) to be programmed.

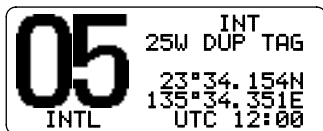

*U.K. version only

- ② Push [16•C] for 1 sec. to select the call channel of the selected channel group.

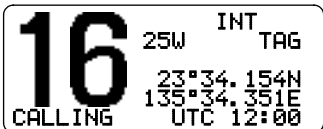

- The call channel number appears.

- ③ Push [16•C] again for 3 sec. (until a long beep changes to 2 short beeps) to enter the call channel programming condition.

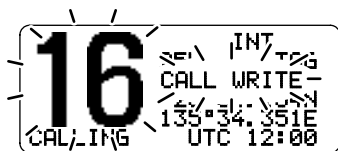

- Channel number and "CALL WRITE" start blinking.

- ④ Push [▲] or [▼] to select the desired channel.

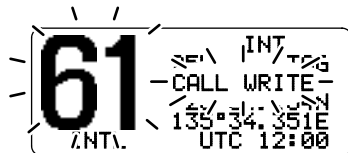

- ⑤ Push [16•C] to program the displayed channel as the call channel.

- Push [CH•DUAL] to cancel.

- The channel number and "CALL WRITE" stop blinking.

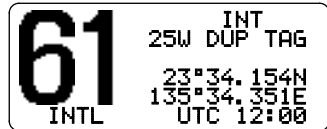

3 BASIC OPERATION

■ Channel comments

Memory channels can be labelled with alphanumeric comments of up to 10 characters each for easy channel recognition.

More than 9 characters comment scrolls automatically at the channel comment indicator after the channel selection.

Capital letters, small letters, numerals, some symbols (— ∙ ↙) and space can be used.

- ① Select the desired memory channel.
 - Cancel dualwatch, tri-watch or scan in advance.
- ② While pushing [**CH•DUAL**], push [**16•C**] to edit the channel comment.
 - A cursor and the first character start blinking alternately.
- ③ Select the desired character by pushing [**▲**] or [**▼**].
 - Push [**CH•DUAL**] or [**16•C**] to move the cursor forward or backward, respectively.
- ④ Repeat step ③ to input all characters.
- ⑤ Push [**ENT**] to set the comment.
 - Push [**CLR**] to cancel.
 - The cursor disappears.
- ⑥ Repeat steps ① to ⑤ to program other channel comments, if desired.

■ Microphone lock function

The microphone lock function electrically locks [**▲**]/[**▼**] and [**HI/LO**] keys on the supplied microphone. This prevents accidental channel changes and function access.

- ➔ While pushing [**HI/LO**] on the microphone, turn power ON to toggle the lock function ON and OFF.

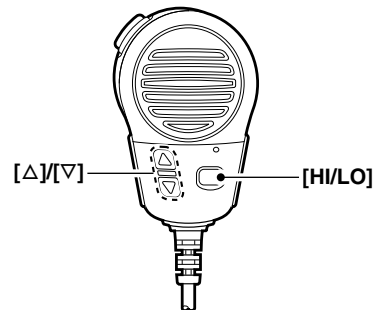

■ Display backlighting

The function display and keys can be backlit for better visibility under low light conditions.

- ➔ While pushing [**SCAN•TAG**], push [**▲**] or [**▼**] to adjust the brightness of the LCD and key backlight.
- The backlight is selectable in 3 levels and OFF.

■ Description

Dualwatch monitors Channel 16 while you are receiving another channel; tri-watch monitors Channel 16 and the call channel while receiving another channel.

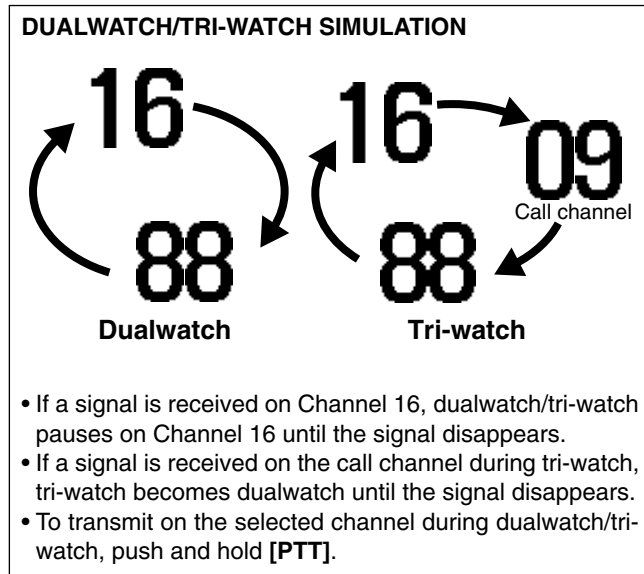

■ Operation

- ① Select Dualwatch or Tri-watch in set mode. (p. 46)
- ② Push [▲] or [▼] to select the desired operating channel.
- ③ Push [CH•DUAL] for 1 sec. to start Dualwatch or Tri-watch.
 - “DUAL 16” appears during dualwatch; “TRI 16” appears during tri-watch.
 - A beep tone sounds when a signal is received on Channel 16.
- ④ To cancel Dualwatch or Tri-watch, push [CH•DUAL] again.

[Example]: Operating tri-watch on INT channel 25.

```

25      INT
      25W DUP TAG
      TRI 16
      23°34.154N
      135°34.351E
TELEPHON  UTC 12:00
    
```

Tri-watch starts.

```

61      BUSY INT
      25W DUP TAG
      TRI 16
      23°34.154N
      135°34.351E
      INTL  UTC 12:00
    
```

Signal is received on call channel.

```

25      BUSY INT
      25W DUP /TAG
      TRI 16
      23°34.154N
      135°34.351E
TELEPHON  UTC 12:00
    
```

Signal is received on Channel 16 takes priority.

```

25      INT
      25W DUP TAG
      TRI 16
      23°34.154N
      135°34.351E
TELEPHON  UTC 12:00
    
```

Tri-watch resumes after the signal disappears.

■ Scan types

Scanning is an efficient way to locate signals quickly over a wide frequency range. The transceiver has priority scan and normal scan.

Set the tag channels (scanned channel) before scanning. Clear the tag channels which inconveniently stop scanning, such as those for digital communication use. (Refer to right page for details.)

/// Choose priority or normal scan in set mode. (p. 45)

PRIORITY SCAN

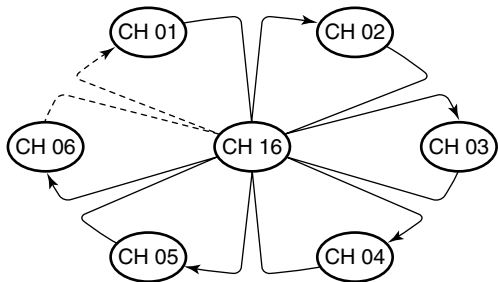

Priority scan searches through all tag channels in sequence while monitoring Channel 16. When a signal is detected on Channel 16, scan pauses until the signal disappears; when a signal is detected on a channel other than Channel 16, scan becomes dualwatch until the signal disappears.

NORMAL SCAN

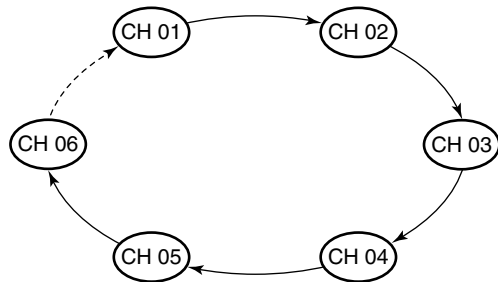

Normal scan, like priority scan, searches through all tag channels in sequence. However, unlike priority scan, Channel 16 is not checked unless Channel 16 is set as a tag channel.

■ Setting tag channels

For more efficient scanning, add the desired channels as tag channels or clear the tag for unwanted channels.

Channels are not tagged will be skipped during scanning. Tag channels can be assigned to each channel group (International and U.S.A.*) independently.

- ① Push both [▲] and [▼] to select the desired channel group (International and U.S.A.*).
- ② Select the desired channel to be set as a tag channel.
- ③ Push [SCAN•TAG] for 1 sec. to set the displayed channel as a tag channel.
 - “TAG” appears in the display.
- ④ To cancel the tag channel setting, repeat step ③.
 - “TAG” disappears.

✓ Clearing (or setting) all tagged channels

While pushing [HI/LO] on the microphone, push [SCAN•TAG] for 3 sec. (until a long beep changes to 2 short beeps) to clear all tag channels in the channel group.

- Repeat above procedure to set all tag channels.

■ Starting a scan

Set scan type (priority or normal scan) and scan resume timer in advance using set mode. (p. 45)

- ① Push [▲] and [▼] to select the desired channel group (International and U.S.A.*) if desired.
- ② Set tag channels as described at left.
- ③ Make sure the squelch is closed to start a scan.
- ④ Push [SCAN•TAG] to start priority or normal scan.
 - “PRI-SCAN 16” or “NORMAL SCAN” appears in the function display.
 - When a signal is detected, scan pauses until the signal disappears or resumes after pausing 5 sec. according to set mode setting. (Channel 16 is still monitored during priority scan.)
 - Push [▲] or [▼] to check the scanning tag channels, to change the scanning direction or resume the scan manually.
 - A beep tone sounds and “16” blinks when a signal is received on Channel 16 during priority scan.
- ⑤ To stop the scan, push [SCAN•TAG].

*U.K. version only

[Example]: Starting a normal scan.

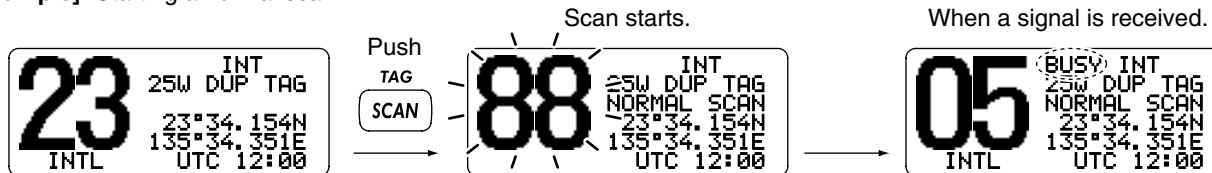

■ MMSI code programming

The 9-digit MMSI (Maritime Mobile Service Identity: DSC self ID) code can be programmed at power ON.

/// **This code programming can be performed only once.**

- ① Turn power OFF.
- ② While pushing [MENU], turn power ON to enter MMSI code programming condition.
- ③ After the display appears, release [MENU].
- ④ Push [MENU] again to enter the DSC menu.
- ⑤ Push [▲] or [▼] to select "Set up," push [ENT].

```

--DSC Menu--
Select Item
Position Input
Received Calls
→Set up
Exit
  
```

- ⑥ Push [▲] or [▼] to select "MMSI Check," push [ENT].

```

--DSC Menu--
Set up
DEL:INDV ID      ▲
DEL:Group ID
Offset Time
→MMSI Check     ▼
  
```

- ⑦ Push [▲] or [▼] to set the specific 9-digit MMSI code.
 - Push [CH•DUAL] or [16•C] to move the cursor forward or backward, respectively.
 - Push [SCAN•TAG] to clear the MMSI code.
 - Push [CLR] to cancel and exit the condition to the set up menu.

```

--DSC Menu--
MMSI Check
Input 9 digits
█-----
<CLR>Exit / ENT>OK>
  
```

- ⑧ After input the 9-digit code, push [ENT] to set the code.
 - Returns to the set up menu.
- ⑨ Push [CLR] or [▼] to select "Exit," push [ENT].
 - Returns to the DSC menu.
 - Repeat again to return to the normal operation condition.

■ MMSI code check

The 9-digit MMSI (DSC self ID) code can be checked.

- ① Push [MENU] to enter the DSC menu.
- ② Push [▲] or [▼] to select "Set up," and push [ENT].

```

--DSC Menu--
Select Item
Polling Request      ▲
Received Calls
Distress Setting
>Set up              ▼
  
```

- ③ Push [▲] or [▼] to select "MMSI Check," push [ENT].

```

--DSC Menu--
Set up
DEL:INDU ID          ▲
DEL:Group ID
Offset Time
>MMSI Check          ▼
  
```

- ④ Check the 9-digit MMSI (DSC self ID) code.

```

--DSC Menu--
MMSI Check
123456789

<CLR>Exit>
  
```

- ⑤ Push [CLR] or [▼] to select "Exit," push [ENT].
 - Returns to the DSC menu.
 - Repeat again to return to the normal operation condition.

6 DSC OPERATION

■ DSC individual ID

A total of 100 DSC address IDs can be programmed and named with up to 10 characters.

◇ Programming Address ID

- ① Push [MENU] to enter the DSC menu.
- ② Push [▲] or [▼] to select “Set up,” and push [ENT].

```
--DSC Menu--
Select Item
Polling Request      ▲
Received Calls
Distress Setting
→Set up              ▼
```

- ③ Push [▲] or [▼] to select “Add: INDV ID,” push [ENT].

```
--DSC Menu--
Set up
→Add:INDV ID
Add:Group ID
DEL:INDV ID
DEL:Group ID        ▼
```

- ④ Push [▲] or [▼] to set the individual ID.
 - Push [CH•DUAL] or [16•C] to move the cursor forward or backward, respectively.
 - Push [SCAN•TAG] to clear the ID.
 - Push [CLR] to cancel and exit the condition to the set up menu.
 - “Full ID” appears when 100 DSC address IDs are already set.

/// 1st digit ‘0’ is fixed for a group ID. When you input 1st digit ‘0’ and other 8 digits, the ID is automatically registered as a group ID.

```
--DSC Menu--
Add:Individual ID
Input 9 digits
>█<-----
/ \
<CLR>Exit / ENT>OK>
```

- ⑤ After input the 9-digit code, push [ENT] to set up to a 10-character ID name using [▲] or [▼].
 - Push [CH•DUAL] or [16•C] to move the cursor forward or backward, respectively.
 - Push [SCAN•TAG] to clear the ID name.
 - Push [CLR] to cancel and exit the condition to the set up menu.

```
--DSC Menu--
Add:Individual ID
Input name
>█<-----
/ \
<CLR>Exit / ENT>OK>
```

- ⑥ Push [ENT] to program.
- ⑦ Push [CLR] or [▼] to select “Exit,” push [ENT].
 - Returns to the DSC menu.
 - Repeat again to return to the normal operation condition.

◆ Deleting address ID

- ① Push [MENU] to enter the DSC menu.
- ② Push [▲] or [▼] to select "Set up," and push [ENT].

```

--DSC Menu--
Select Item
Polling Request      ▲
Received Calls
Distress Setting
→Set up              ▼
  
```

- ③ Push [▲] or [▼] to select "DEL: INDU ID," push [ENT].
 - When no address ID is programmed, "No ID" is displayed.
 - Push [CLR] to exit the condition.

```

--DSC Menu--
Set up
Add: INDU ID
Add: Group ID
→DEL: INDU ID
DEL: Group ID      ▼
  
```

- ④ Push [▲] or [▼] to select the desired ID name for deleting.

```

--DSC Menu--
Select ID
Bob
John
→Cindy              ▼
<CLR>Exit / ENT>OK>
  
```

- ⑤ Push [ENT] to delete the address ID and returns to the set up menu.
- ⑥ Push [CLR] or [▼] to select "Exit," push [ENT].
 - Returns to the DSC menu.
 - Repeat again to return to the normal operation condition.

6 DSC OPERATION

◆ Programming Group ID

- ① Push **[MENU]** to enter the DSC menu.
- ② Push **[▲]** or **[▼]** to select “Set uP,” and push **[ENT]**.

```
      --DSC Menu--
Select Item
Polling Request      ▲
Received Calls
Distress Setting
→Set uP              ▼
```

- ③ Push **[▲]** or **[▼]** to select “Add:Group ID,” push **[ENT]**.

```
      --DSC Menu--
Set uP
Add:INDV ID
→Add:Group ID
DEL:INDV ID
DEL:Group ID        ▼
```

- ④ Push **[▲]** or **[▼]** to set the Group ID.
 - 1st digit ‘0’ is fixed for a group ID.
 - Push **[CH•DUAL]** or **[16•C]** to move the cursor forward or backward, respectively.
 - Push **[SCAN•TAG]** to clear the ID.
 - Push **[CLR]** to cancel and exit the condition to the set up menu.
 - “Full ID” appears when 100 DSC address IDs are already set.

```
      --DSC Menu--
Add:Group ID
Input 8 digits
  █
  ▲
  ▼
<CLR→Exit / ENT→OK>
```

- ⑤ After input the 8-digit code, push **[ENT]** to input up to a 10-character ID name using **[▲]** or **[▼]**.
 - Push **[CH•DUAL]** or **[16•C]** to move the cursor forward or backward, respectively.
 - Push **[SCAN•TAG]** to clear the ID name.
 - Push **[CLR]** to cancel and exit the condition to the set up menu.

```
      --DSC Menu--
Add:Group ID
Input name
  █
  ▲
  ▼
<CLR→Exit / ENT→OK>
```

- ⑥ Push **[ENT]** to program.
- ⑦ Push **[CLR]** or **[▼]** to select “Exit,” push **[ENT]**.
 - Returns to the DSC menu.
 - Repeat again to return to the normal operation condition.

◆ Deleting group ID

- ① Push [MENU] to enter the DSC menu.
- ② Push [▲] or [▼] to select "Set up," and push [ENT].

```

--DSC Menu--
Select Item
Polling Request      ▲
Received Calls
Distress Setting
→Set up              ▼
  
```

- ③ Push [▲] or [▼] to select "DEL:Group ID," push [ENT].
 - When no group ID is programmed, "No ID" is displayed. Push [CLR] to exit the condition.

```

--DSC-Menu--
Set up
Add:INDU ID
Add:Group ID
DEL:INDU ID
→DEL:Group ID      ▼
  
```

- ④ Push [▲] or [▼] to select the desired ID name for deleting.

```

--DSC Menu--
Select ID
Office
Icom
→Station A          ▼
<CLR→Exit / ENT→OK>
  
```

- ⑤ Push [ENT] to delete the group ID and returns to the set up menu.
- ⑥ Push [CLR] or [▼] to select "Exit," push [ENT].
 - Returns to the DSC menu.
 - Repeat again to return to the normal operation condition.

■ Position and time programming

A distress call should include the ship's position and time data. If no GPS is connected, your position and UTC (Universal Time Coordinated) time should be input manually. They are included automatically when a GPS receiver (NMEA0183 ver. 2.0 or 3.01) is connected.

- ① Push [MENU] to enter the DSC menu.
- ② Push [▲] or [▼] to select "Position InPut," and push [ENT].

```

--DSC Menu--
Select Item
>Position InPut
Individual Call
Group Call
All ShiPs Call
    
```

- ③ The position information appears. Set your latitude data using [▲] or [▼]. After setting the latitude data, push [ENT] to set your longitude data.
 - Push [CH•DUAL] or [16•C] to move the cursor forward or backward, respectively.
 - Push [▲] or [▼] to edit N; North latitude or S; South latitude when the cursor is on the 'N' or 'S' position, and W; West longitude or E; East longitude when the cursor is on the 'W' or 'E' position.
 - Push [SCAN•TAG] to clear the latitude/longitude data.
 - Push [CLR] to cancel and exit the condition to the DSC menu.

```

--DSC Menu--
InPut Position
Latitude
>█<--N Null
/<SCAN>Null Data>
<CLR>Exit / ENT>OK>
    
```

Set the latitude data

```

--DSC Menu--
InPut Position
Longitude
>█<--W Null
/<SCAN>Null Data>
<CLR>Exit / ENT>OK>
    
```

Set the longitude data

■ Distress call

A distress call should be transmitted, if in the opinion of the Master, the ship or a person is in distress and requires immediate assistance.

NEVER USE THE DISTRESS CALL WHEN YOUR SHIP OR A PERSON IS NOT IN AN EMERGENCY. A DISTRESS CALL CAN BE USED ONLY WHEN IMMEDIATE HELP IS NEEDED.

◆ Simple call

- ① Confirm no distress call is being received.
- ② While lifting up the key cover, push **[DISTRESS]** for 5 sec. to transmit the distress call.
 - Emergency channel (Ch 70) is automatically selected and the distress call is transmitted.
 - When no GPS is connected, input your position and UTC time, if possible.
 - While pushing **[DISTRESS]**, the key backlighting is blinking.

Distress Call
Push for 5 sec.

- ③ After transmitting the distress call, the transceiver waits for an acknowledgment call on Ch 70.
 - The distress call is automatically transmitted every 3.5 to 4.5 minutes.
 - After 2 sec., the transceiver is set to Channel 16 automatically.

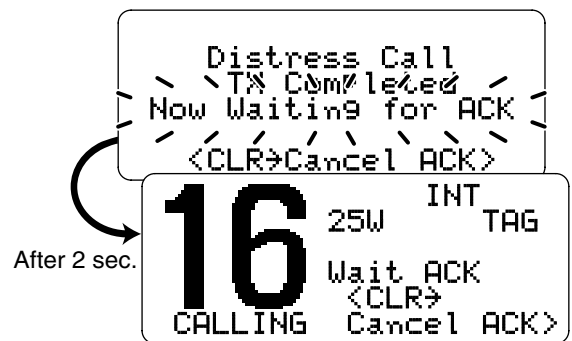

- ④ After receiving the acknowledgment, reply using the microphone.

16 25W INT TAG
RCV DTRS ACK
CALLING <Osaka Bay
<CLR>
Beep Off

- ➔ A distress alert contains (default);
 - Nature of distress: Undesignated distress
 - Position data : GPS or manual input position data held for 23.5 hrs or until the power is turned OFF.
- ➔ The distress call is repeated every 3.5–4.5 min., until receiving an ‘acknowledgement.’
- ➔ Push [CLR] to cancel the ‘Call repeat’ mode.
- ➔ “??” may blink instead of position and time indications when the GPS data is invalid, or has not been manually updated after 4 hours.

◇ Normal call

The nature of the distress call should be included in the distress call.

- ① Push [MENU] to enter the DSC menu.
- ② Push [▲] or [▼] to select “Distress Setting,” and push [ENT].

```

--DSC Menu--
Select Item
Position Report      ▲
Polling Request
Received Calls
→Distress Setting   ▼
  
```

- ③ Push [▲] or [▼] to select the nature of the distress, push [ENT].
 - ‘Undesignated,’ ‘Explosion,’ ‘Flooding,’ ‘Collision,’ ‘Grounding,’ ‘Capsizing,’ ‘Sinking,’ ‘Adrift (Disable adrift),’ ‘Abandoning (Abandoning ship),’ ‘Piracy (Piracy attack),’ and ‘MOB (Man overboard)’ are available.
 - The selected nature of the distress is stored for 10 minutes.

```

--DSC Menu--
Select Nature
Undesignated
→Explosion
Flooding
<CLR>Exit / ENT→OK> ▼
  
```

- ⑧ After receiving the acknowledgment, reply using the microphone.

```

16          INT
           25W TAG
           RCV DTRS ACK
           <Osaka Bay
           <CLR>
CALLING Beep Off>

```

- ➔ A distress alert contains (default);
 - Nature of distress: Undesignated distress
 - Position data : GPS or manual input position data held for 23.5 hrs or until the power is turned OFF.
- ➔ The distress call is repeated every 3.5–4.5 min., until receiving an ‘acknowledgement.’
- ➔ Push [CLR] to cancel the ‘Call repeat’ mode.
- ➔ “??” may blink instead of position and time indications when the GPS data is invalid, or has not been manually updated after 4 hours.

■ Transmitting DSC calls

◇ Transmitting an individual call

The individual call function allows you to transmit a DSC signal to a specific ship only.

- ① Push [MENU] to enter the DSC menu.
- ② Push [▲] or [▼] to select “Individual Call,” and push [ENT].

```

--DSC Menu--
Select Item
Position InPut
➔Individual Call
Group Call
All SHIPs Call

```

- ③ Push [▲] or [▼] to select the desired pre-programmed individual address or “Manual InPut,” push [ENT].
 - The ID code for the individual call can be set in advance. (p. 16)
 - When “Manual InPut” is selected, set the 9-digit ID code for the individual you wish to call with [▲] or [▼].
 - /// 1st digit ‘0’ is fixed for a group ID.

```

--DSC Menu--
Select Address
Manual InPut
Bob
➔John
<CLR>Exit / ENT>OK>

```

6 DSC OPERATION

- ④ Push [▲] or [▼] to select a desired intership channel or "Manual InPut," push [ENT].

- Intership channels are already preset into the transceiver in recommending order.

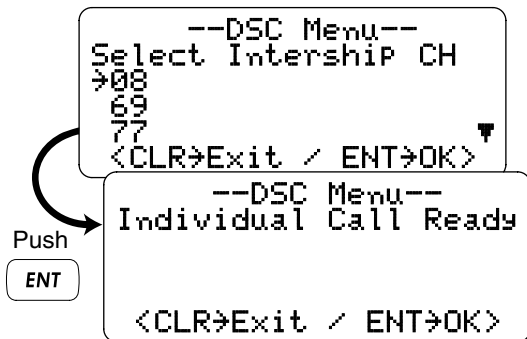

- ⑤ Push [ENT] to transmit the individual call.

- If Channel 70 is busy, the transceiver stands by until the channel becomes clear.

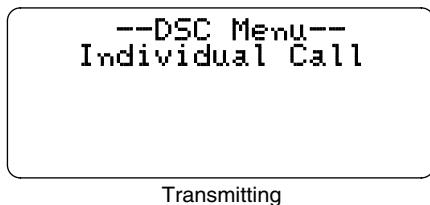

- ⑥ Standby on Channel 70 until an acknowledgement is received.

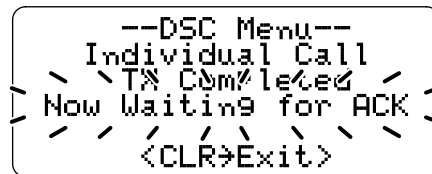

- ⑦ When the acknowledgement 'Able to comply' is received, the specified channel (in step ④) is selected with beeps automatically. Or, when the acknowledgement 'Unable to comply' is received, the display returns to the operated channel (before enter the DSC menu) with beeps.

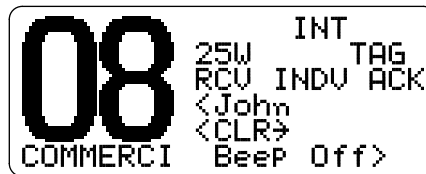

'Able to comply' is received.

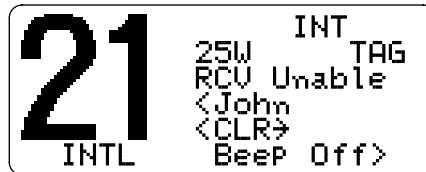

'Unable to comply' is received.

- ⑧ Push [CLR] to stop the beep, then push and hold [PTT] to communicate your message to the responding ship.

◆ Transmitting an individual acknowledgement

When receiving an individual call, you can transmit an acknowledgement ('Able to comply' or 'Unable to comply') by using the on screen prompts (see page 38 for details). Alternatively, you can send an acknowledgement through the menu system as follows.

- ① Push [MENU] to enter the DSC menu.
- ② Push [▲] or [▼] to select "Individual ACK," and push [ENT].
 - "Individual ACK" item appears after an individual call is received.

```

--DSC Menu--
Select Item
Position Input
Individual Call
>Individual ACK
Group Call
  
```

- ③ Push [▲] or [▼] to select the desired individual address or ID code, push [ENT].

```

--DSC Menu--
Select Address
>John           01
Beck           02
Bob            03
<CLR>Exit / ENT>OK>
  
```

- ④ Push [▲] or [▼] to select that you can comply to the call or not from "Able to Comply" or "Unable to Comply," then push [ENT].
 - When "Unable to Comply" is selected, the reason "No Reason Given" will be transmitted.

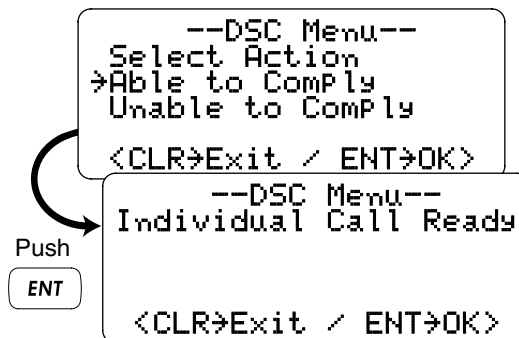

- ⑤ Push [ENT] to transmit the acknowledgement call to the selected station.
- ⑥ After the individual acknowledgement call has been transmitted, the specified channel (specified by the calling station) is selected automatically when "Able to Comply" is selected, or returns to the previous condition (before entering the DSC menu) when "Unable to Comply" is selected in step ④.

6 DSC OPERATION

◆ Transmitting a group call

The group call function allows you to transmit a DSC signal to a specific group only.

- ① Push **[MENU]** to enter the DSC menu.
- ② Push **[▲]** or **[▼]** to select "Group Call," and push **[ENT]**.

```
--DSC Menu--
Select Item
Position Input
Individual Call
→Group Call
All Ships Call
```

- ③ Push **[▲]** or **[▼]** to select the desired pre-programmed group address or "Manual Input," push **[ENT]**.
 - The ID code for the group call can be set in advance. (p. 18)
 - When "Manual Input" is selected, set the 8-digit ID code for the group you wish to call with **[▲]** or **[▼]**.

```
--DSC Menu--
Select Address
Manual Input
→Office
Icom
<CLR>Exit / ENT→OK
```

- ④ Push **[▲]** or **[▼]** to select a desired intership channel or "Manual Input," push **[ENT]**.
 - Intership channels are already preset into the transceiver in recommending order.

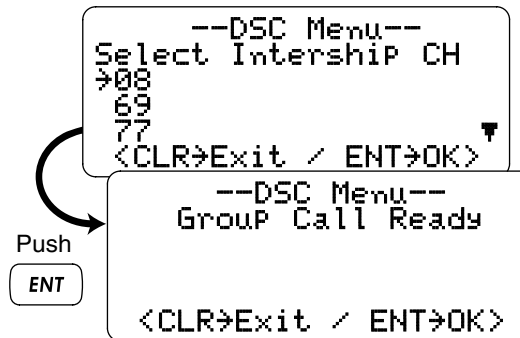

- ⑤ Push **[ENT]** to transmit the group call.
 - If Channel 70 is busy, the transceiver stands by until the channel becomes clear.
- ⑥ After the group call has been transmitted, the following indication is displayed.

```
--DSC Menu--
Group Call
TX Completed
<CLR>Exit
```

- ⑦ Push **[CLR]** to exit the condition and selects the specified intership channel in step ④ automatically.
 - Even if **[CLR]** hasn't been pushed, the transceiver selects the specified intership channel in step ④ automatically after 2 sec. of inactivity.

◆ Transmitting an all ships call

Large ships use Channel 70 as their 'listening channel.' When you want to announce a message to these ships, use the all ships call function.

- ① Push [MENU] to enter the DSC menu.
- ② Push [▲] or [▼] to select "All Ships Call," and push [ENT].

```

--DSC Menu--
Select Item
Position Input
Individual Call
Group Call
➔All Ships Call

```

- ③ Push [▲] or [▼] to select the desired category, push [ENT].
 - The selectable category may differ according to the programmed setting. Ask your dealer for the available categories.

```

--DSC Menu--
Select Category
➔Safety
Urgency
<CLR>Exit / ENT>OK>

```

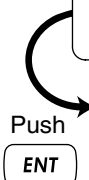

```

--DSC Menu--
All Ships Call Ready
<CLR>Exit / ENT>OK>

```

- ④ Push [ENT] to transmit the all ships call.
 - Channel 70 is selected and the all ships call is transmitted.

```

--DSC Menu--
All Ships Call

```

Transmitting

- ⑤ After the all ships call has been transmitted, the following indication is displayed.

```

--DSC Menu--
All Ships Call
TX Completed

<CLR>Exit>

```

- ⑥ Push [CLR] to exit the condition and selects Channel 16 automatically.
 - Even if [CLR] hasn't been pushed, the transceiver automatically selects Channel 16 after 2 sec. of inactivity.

6 DSC OPERATION

◆ Transmitting a position request call

Transmit a position request call when you want to know a specific ship's current position, etc.

- ① Push **[MENU]** to enter the DSC menu.
- ② Push **[▲]** or **[▼]** to select "Position Request," and push **[ENT]**.

```
--DSC Menu--
Select Item
Individual Call      ▲
Group Call
All Ships Call
→Position Request  ▼
```

- ③ Push **[▲]** or **[▼]** to select the desired pre-programmed individual address or "Manual Input," push **[ENT]**.
 - The ID code can be set in advance. (p. 16)
 - When "Manual Input" is selected, set the 9-digit ID code for the individual you wish to call with **[▲]** or **[▼]**.

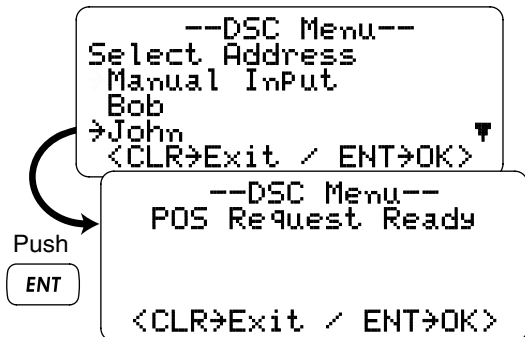

- ④ Push **[ENT]** to transmit the position request call.
 - If Channel 70 is busy, the transceiver stands by until the channel becomes clear.

```
--DSC Menu--
Position Request
```

Transmitting

- ⑤ After the position request call has been transmitted, the following indication is displayed.

```
--DSC Menu--
Position Request
  \ TX Completed /
 / Now Waiting for ACK \
  \ <CLR>Exit >
```

- ⑥ Push **[CLR]** to return to the previous indication before entering the DSC menu.
 - Even if **[CLR]** hasn't been pushed, the display automatically returns to the previous indication after 2 sec. of inactivity.

◆ **Transmitting a position report call**

Transmit a position report call when you want to announce your own position to a specific ship and to get an answer, etc.

- ① Push [MENU] to enter the DSC menu.
- ② Push [▲] or [▼] to select “Position RePort,” and push [ENT].

```

--DSC Menu--
Select Item
Group Call          ▲
All Ships Call
Position Request
→Position Report   ▼
    
```

- ③ Push [▲] or [▼] to select the desired pre-programmed individual address or “Manual InPut,” push [ENT].
 - The ID code can be set in advance. (p. 16)
 - When “Manual InPut” is selected, set the 9-digit ID code for the individual you wish to call with [▲] or [▼].

```

--DSC Menu--
Select Address
Manual InPut
Bob
→John              ▼
<CLR>Exit / ENT>OK>
    
```

When a GPS receiver (NMEA0183 ver. 2.0 or 3.01) is connected, next steps ④, ⑤ (Current position/time programming) do not appear. Go to step ⑥.

- ④ The position information appears. Set your latitude data using [▲] or [▼]. After setting the latitude data, push [ENT] to set your longitude data.
 - Push [CH•DUAL] or [16•C] to move the cursor forward or backward, respectively.
 - Push [▲] or [▼] to edit N; North latitude or S; South latitude when the cursor is on the ‘N’ or ‘S’ position, and W; West longitude or E; East longitude when the cursor is on the ‘W’ or ‘E’ position.
 - Push [SCAN•TAG] to clear the latitude/longitude data.
 - Push [CLR] to cancel and exit the condition to the DSC menu.

```

--DSC Menu--
InPut Position
Latitude
█ □ . . . . N      Null
<SCAN>Null Data>
<CLR>Exit / ENT>OK>
    
```

Set the latitude data

```

--DSC Menu--
InPut Position
Longitude
█ □ . . . . W      Null
<SCAN>Null Data>
<CLR>Exit / ENT>OK>
    
```

Set the longitude data

6 DSC OPERATION

- ⑤ After setting the longitude data, push [ENT] to set the time information appears. Set the current UTC time with [▲] or [▼], then push [ENT].
- Push [CH•DUAL] or [16•C] to move the cursor forward or backward, respectively.
 - Push [SCAN•TAG] to clear the UTC time data.
 - Push [CLR] to cancel and exit the condition to the DSC menu.

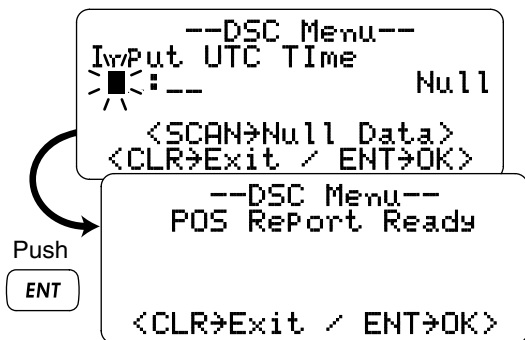

- ⑥ Push [ENT] to transmit the position report call.
- If Channel 70 is busy, the transceiver stands by until the channel becomes clear.

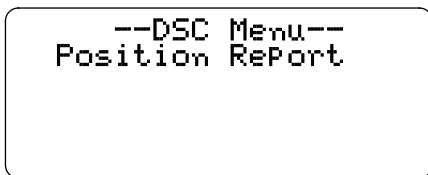

Transmitting

- ⑦ After the position report call has been transmitted, the following indication is displayed.

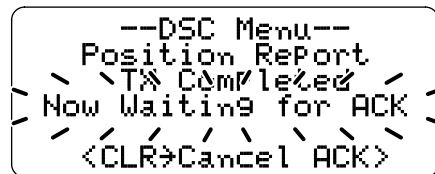

- ⑧ Push [CLR] to return to the previous indication before entering the DSC menu.
- Even if [CLR] hasn't been pushed, the display automatically returns to the previous indication after 2 sec. of inactivity.

◆ Transmitting a polling request call

Transmit a polling request call when you want to know a specific ship is in the communication area, etc.

- ① Push [MENU] to enter the DSC menu.
- ② Push [▲] or [▼] to select "Polling Request," and push [ENT].

```

--DSC Menu--
Select Item
All Ships Call      ▲
Position Request
Position Report
→Polling Request   ▼
    
```

- ③ Push [▲] or [▼] to select the desired pre-programmed individual address or "Manual Input," push [ENT].
 - The ID code can be set in advance. (p. 16)
 - When "Manual Input" is selected, set the 9-digit ID code for the individual you wish to call with [▲] or [▼].

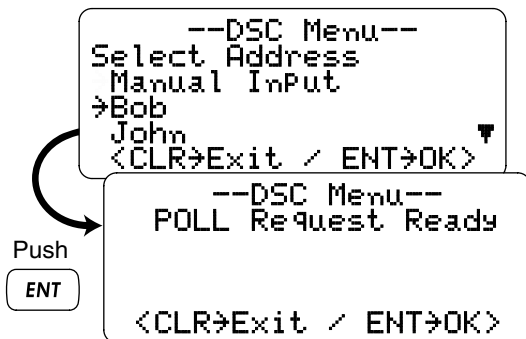

- ④ Push [ENT] to transmit the polling request call.
 - If Channel 70 is busy, the transceiver stands by until the channel becomes clear.

```

--DSC Menu--
Polling Request
    
```

Transmitting

- ⑤ After the polling request call has been transmitted, the following indication is displayed.

```

--DSC Menu--
Polling Request
  \TX Completed /
Now Waiting for ACK
<CLR>Cancel ACK>
    
```

- ⑥ Push [CLR] to return to the previous indication before entering the DSC menu.
 - Even if [CLR] hasn't been pushed, the display automatically returns to the previous indication after 2 sec. of inactivity.

- ⑤ After setting the longitude data, push [ENT] to set the time information appears. Set the current UTC time with [▲] or [▼], then push [ENT].
 - Push [CH•DUAL] or [16•C] to move the cursor forward or backward, respectively.
 - Push [SCAN•TAG] to clear the UTC time data.
 - Push [CLR] to cancel and exit the condition to the DSC menu.

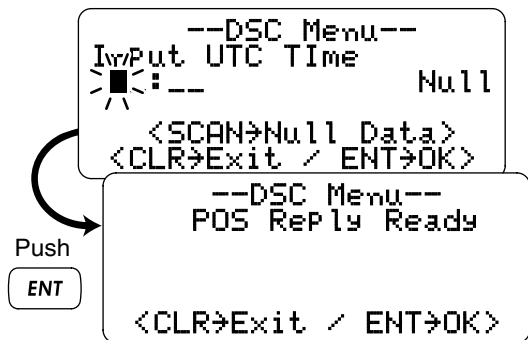

- ⑥ Push [ENT] to transmit the position reply call to the selected station.
 - Your position data is transmitted, when [ENT] is pushed.

◆ Transmitting a position report reply call

Transmit a position report reply call when a position report call is received.

- ① Push [MENU] to enter the DSC menu.
- ② Push [▲] or [▼] to select “POS Report Reply,” and push [ENT].
 - “POS Report Reply” item appears after a position report call is received.

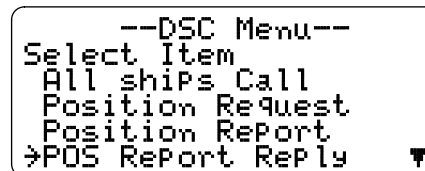

- ③ Push [▲] or [▼] to select the desired individual address or ID code, push [ENT].

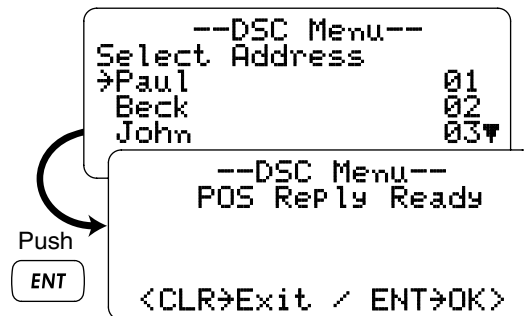

- ④ Push [ENT] to transmit the position report reply call to the selected station.

6 DSC OPERATION

◆ Transmitting a polling reply call

Transmit a polling reply call when a polling request call is received.

- ① Push **[MENU]** to enter the DSC menu.
- ② Push **[▲]** or **[▼]** to select "Polling Reply," and push **[ENT]**.
 - "Polling Reply" item appears after a polling request call is received.

```
--DSC Menu--
Select Item
Position Request
Position Report
Polling Request
→Polling Reply      ▼
```

- ③ Push **[▲]** or **[▼]** to select the desired individual address or ID code, push **[ENT]**.

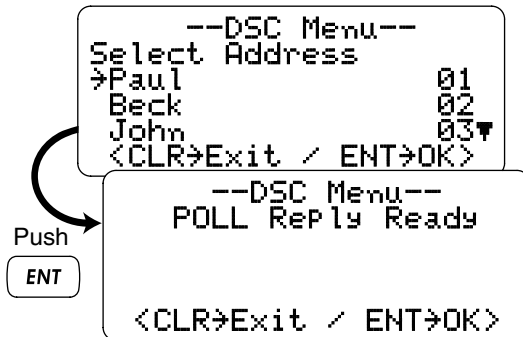

- ④ Push **[ENT]** to transmit the polling request call to the selected station.

■ Receiving DSC calls

◇ Receiving a distress call

While monitoring Channel 70 and a distress call is received:

- ➔ The emergency alarm sounds for 2 minutes.
 - Push [CLR] to stop the alarm.
- ➔ "RCV DISTRESS" appears in the display, then Channel 16 is automatically selected.
- ➔ Continue monitoring Channel 16 as a coast station may require assistance.

```

16      25W  INT  TAG
      RCV DISTRESS
      <Paul
      <CLR>
CALLING Beep Off>
  
```

◇ Receiving a distress acknowledgement

While monitoring Channel 70 and a distress acknowledgement to other ship is received:

- ➔ The emergency alarm sounds for 2 minutes.
 - Push [CLR] to stop the alarm.
- ➔ "RCV DTRS ACK" appears in the display, then Channel 16 is automatically selected.

```

16      25W  INT  TAG
      RCV DTRS ACK
      <Beck
      <CLR>
CALLING Beep Off>
  
```

◇ Receiving a distress relay call

While monitoring Channel 70 and a distress relay acknowledgement is received:

- ➔ The emergency alarm sounds for 2 minutes.
 - Push [CLR] to stop the alarm.
- ➔ "RCV DTRS REL" appears in the display, then Channel 16 is automatically selected.

```

16      25W  INT  TAG
      RCV DTRS REL
      <Bob
      <CLR>
CALLING Beep Off>
  
```

6 DSC OPERATION

◇ Receiving an individual call

While monitoring Channel 70 and an individual call is received:

- The emergency alarm or beeps sound depending on the received category.
- "RCV INDV" appears in the display.
- Push [CLR] to stop the beep, then push [ENT] to reply the call and select the channel specified by the calling station for voice communication (depending on your replying condition see p. 27 for individual acknowledgement call procedure for details.); push [CLR] to ignore the individual call.

```
06          INT TAG
          25W  RCV INDV
          <Paul
          <CLR>
SAFETY      Beep Off>
```

◇ Receiving a group call

While monitoring Channel 70 and a group call is received:

- The emergency alarm or beeps sound depending on the received category.
- "RCV GROUP" appears in the display.
- Push [CLR] to stop the beep, then push [ENT] to select the channel specified by the calling station for voice communication; push [CLR] to ignore the group call.

```
06          INT TAG
          25W  RCV GROUP
          <Icom
          <CLR>
SAFETY      Beep Off>
```

◇ Receiving an all ships call

While monitoring Channel 70 and an all ships call is received:

- The emergency alarm sounds when the category is 'Distress' or 'Urgency'; beeps sound for 2 minutes.
- "RCV ALL SHIP" appears in the display.
- Push [CLR] to stop the beep, then push [ENT] to monitor channel 16 for an announcement from the calling vessel, push [CLR] to ignore the call.

```
06          INT TAG
          25W  RCV ALL SHIP
          <Tokyo Bay
          <CLR>
SAFETY      Beep Off>
```

◇ Receiving a geographical area call

While monitoring Channel 70 and a geographical area call (for the area you are in) is received:

- ➔ Emergency alarm or beeps sound depending on the received category.
- ➔ "RCV GEOGRAPH" appears in the display.

```

06          INT
           25W TAG
           RCV GEOGRAPH
           <Osaka Bay
           <CLR>
SAFETY     Beep Off>
  
```

- ➔ Push [CLR] to stop the beep, then push [ENT] to change to the channel specified by the calling station for voice communication; push other key to ignore the Geographical Area call.
- ➔ Monitor the selected channel for an announcement from the calling station.

When no GPS receiver is connected or if there is a problem with the connected receiver, all geographical area calls are received, regardless of your position.

◇ Receiving a position request call

While monitoring Channel 70 and a position request call is received:

- ➔ "RCV POS REQ" appears in the display.
- ➔ Push [CLR] to stop the beep, then push [ENT] to reply to the position request call; push [CLR] to ignore the position request call.

```

06          INT
           25W TAG
           RCV POS REQ
           <Paul
           <CLR>
SAFETY     Beep Off>
  
```

◇ Receiving a position report call

While monitoring Channel 70 and a position report call is received:

- ➔ "RCV POS RPT" appears in the display.
- ➔ Push [CLR] to stop the beep, then push [ENT] to reply to the position report call; push [CLR] to ignore the position report call.

```

06          INT
           25W TAG
           RCV POS RPT
           <Paul
           <CLR>
SAFETY     Beep Off>
  
```

6 DSC OPERATION

◆ Receiving a polling request call

While monitoring Channel 70 and a polling request call is received:

- "RCV POLL REQ" appears in the display.
- Push **[CLR]** to stop the beep, then push **[ENT]** to reply to the call; push **[CLR]** to ignore the call.

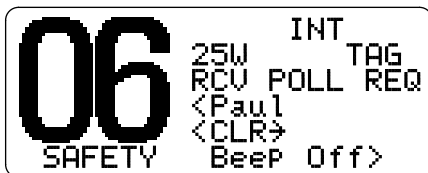

The screenshot shows a digital display with the number '06' in large characters on the left. To its right, the text '25W INT TAG' is displayed. Below this, 'RCV POLL REQ' is shown. Further down, '<Paul' and '<CLR>' are visible. At the bottom, 'SAFETY' is on the left and 'Beep Off>' is on the right.

◆ Receiving a position report reply call

While monitoring Channel 70 and a position report reply call is received:

- "RCV POS RPY" appears in the display.
- Push **[CLR]** to stop the beep, then push **[ENT]** to display the position information; push **[CLR]** to ignore the reply call.

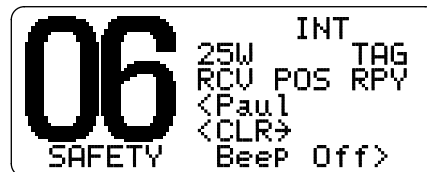

The screenshot shows a digital display with the number '06' in large characters on the left. To its right, the text '25W INT TAG' is displayed. Below this, 'RCV POS RPY' is shown. Further down, '<Paul' and '<CLR>' are visible. At the bottom, 'SAFETY' is on the left and 'Beep Off>' is on the right.

◆ Receiving a position reply call

While monitoring Channel 70 and a position reply call is received:

- "RCV POS RPY" appears in the display.
- Push **[CLR]** to stop the beep, then push **[ENT]** to display the position information; push **[CLR]** to ignore the reply call.

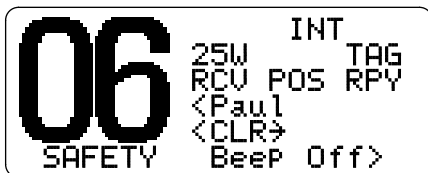

The screenshot shows a digital display with the number '06' in large characters on the left. To its right, the text '25W INT TAG' is displayed. Below this, 'RCV POS RPY' is shown. Further down, '<Paul' and '<CLR>' are visible. At the bottom, 'SAFETY' is on the left and 'Beep Off>' is on the right.

■ Received messages

The transceiver automatically stores up to 20 distress messages and 20 other messages. The messages can be used as an assistance to the logbook.

- ① Push [MENU] to enter the DSC menu.
- ② Push [▲] or [▼] to select "Received Calls," and push [ENT].

```

--DSC Menu--
Select Item
Position Request  ▲
Position Report
Polling Request
→Received Calls  ▼
  
```

◆ Distress message

- ① Push [▲] or [▼] to select "Distress," push [ENT].

```

--DSC Menu--
Select Message
→Distress
Other
<CLR>Exit / ENT>OK>
  
```

- ② Push [▲] or [▼] to scroll to the desired message, push [ENT].

- Messages which are blinking have not read.

```

--DSC Menu--
Select Message
→12:15 Beck 01
09:10 John 02
<CLR>Exit / ENT>OK>
  
```

- ③ Push [▲] or [▼] to scroll the message.

```

--DSC Menu--
Distress
<Beck
Explosion
LAT: 12°34.567N
LON: 123°45.678W
UTC: 12:15
<CLR>Exit / SCAN>Del>
  
```

▲
↑
↓
▼

- ④ Push [CLR] to exit the condition or push [SCAN] to delete the displayed message and returns to DSC menu.

6 DSC OPERATION

◆ Other messages

- ① Push [▲] or [▼] to select "Other," push [ENT].

```
    --DSC Menu--  
Select Message  
Distress  
→Other  
  
<CLR>Exit / ENT>OK>
```

- ② Push [▲] or [▼] to scroll to the desired message, push [ENT].

- Messages which are blinking have not read.

```
    --DSC Menu--  
Select Message  
All Ships Call      01  
Priority Call       02  
→Individual Call   03  
<CLR>Exit / ENT>OK>
```

- ③ Push [▲] or [▼] to scroll the message.
- The stored message has various information and depending on the type of distress call.

```
    --DSC Menu--  
Individual Call  
<Bob  
Routine  
F3E simplex  
CH08  
<CLR>Exit / SCAN>Del>
```

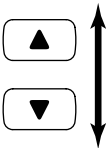

- ④ Push [CLR] to exit the condition or push [SCAN] to delete the displayed message and returns to DSC menu.

■ DSC Set mode

- ◆ **MMSI code check** (See p. 15 for detail)
- ◆ **Add Address ID** (See p. 16 for detail)
- ◆ **Delete Address ID** (See p. 17 for detail)

◆ Offset time

This item sets the offset time from the UTC (Universal Time Coordinated) time.

- ① Push **[MENU]** to enter the DSC menu.
- ② Push **[▲]** or **[▼]** to select "Set up," and push **[ENT]**.

```

--DSC Menu--
Select Item
Polling Request      ▲
Received Calls
Distress Setting9
->Set up              ▼
  
```

- ③ Push **[▲]** or **[▼]** to select "Offset Time," push **[ENT]**.

```

--DSC-Menu--
Set up
Add:Group ID        ▲
DEL:INDU ID
DEL:Group ID
->Offset Time       ▼
  
```

- ④ Set the offset time from the UTC (Universal Time Coordinated) time using **[▲]** or **[▼]**.
 - Push **[CH•DUAL]** or **[16•C]** to move the cursor forward or backward, respectively.
 - Push **[SCAN•TAG]** to clear the offset time data.
 - Push **[CLR]** to cancel and exit the condition to the set up menu.

```

--DSC Menu--
Input Offset Time
  0:00
<CLR>Exit / ENT>OK>
  
```

No offset time (default)

```

--DSC Menu--
Input Offset Time
-12:00
<CLR>Exit / ENT>OK>
  
```

-12 hours

- ⑤ Push **[ENT]** to program and to exit the condition to the set up menu.

/// The local time indication is not available when the GPS receiver (sentence formatter RMC) is connected, the transceiver's display indicates UTC time only.

6 DSC OPERATION

◆ Automatic acknowledgement

This item sets the automatic acknowledgement function ON or OFF.

When a position request, position report or polling request call is received, transceiver automatically transmits a position request reply, position report reply or polling reply call, respectively.

- ① Push [MENU] to enter the DSC menu.
- ② Push [▲] or [▼] to select "Set uP," and push [ENT].

```
--DSC Menu--
Select Item
Polling Request      ▲
Received Calls
Distress Setting9
→Set uP              ▼
```

- ③ Push [▲] or [▼] to select "Auto ACK," push [ENT].

```
--DSC Menu--
Set uP
DEL:Group ID        ▲
Offset Time
MMSI Check
→Auto ACK          ▼
```

- ④ Push [▲] or [▼] to turn the automatic acknowledgement function ON or OFF.

```
--DSC Menu--
Auto ACK
→ON
OFF
<CLR>Exit / ENT>OK>
```

- ⑤ Push [ENT] to set the condition.
 - Push [CLR] to cancel and exit the condition to the set up menu.

7 SET MODE

◆ Dual/Tri-watch

Select the watch function from Dualwatch or tri-watch. (p. 11)

```
    --Set Mode--  
Dual/Tri  
Tri-watch  
→Dualwatch  
  
    <ENT>OK>
```

Dualwatch (default)

◆ Beep tone

You can select the silent operation by turning beep tones OFF, or you can have confirmation beeps sound at the push of a key by turning beep tones ON.

```
    --Set Mode--  
Beep  
→ON  
OFF  
  
    <ENT>OK>
```

Beep tone ON (default)

◆ Backlight

The LCD backlight level can be adjusted from OFF, Min (dark), Mid and Max (bright).

```
    --Set Mode--  
Backlight  
→Max  
Mid  
Min  
  
    <ENT>OK>
```

LCD backlight level MAX (default)

◆ LCD contrast

This item adjusts the contrast of the LCD in 8 steps. 1 is the lowest contrast, and 8 is the highest contrast.

```
    --Set Mode--  
Contrast  
8  
5  
→4  
  
    <ENT>OK>
```

LCD contrast level 4 (default)

■ Supplied accessories

The following accessories are supplied:

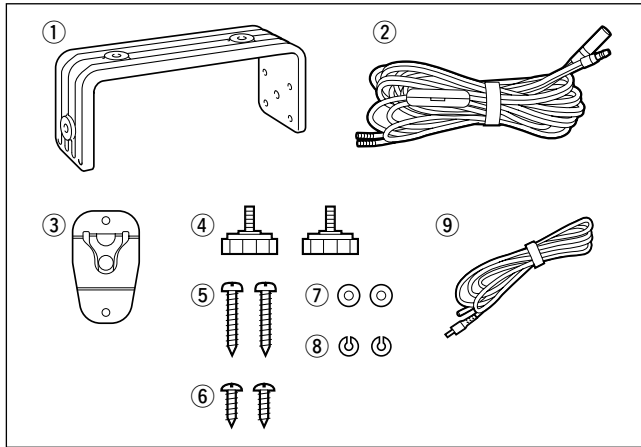

| | Qty. |
|--|------|
| ① Mounting bracket | 1 |
| ② DC power cable (OPC-891) | 1 |
| ③ Microphone hanger | 1 |
| ④ Knob bolts for mounting bracket | 2 |
| ⑤ Screws for mounting bracket (5 × 20) | 2 |
| ⑥ Mic hanger screws (3 × 16) | 2 |
| ⑦ Flat washers for mounting bracket (M5) | 2 |
| ⑧ Spring washers for mounting bracket (M5) | 2 |
| ⑨ RCA connector cable (OPC-1278) | 1 |

■ Antenna

A key element in the performance of any communication system is an antenna. Ask your dealer about antenna and the best place to mount them.

■ Fuse replacement

One fuse is installed in the supplied DC power cable. If a fuse blows or the transceiver stops functioning, track down the source of the problem, if possible, and replace the damaged fuse with a new, rated one.

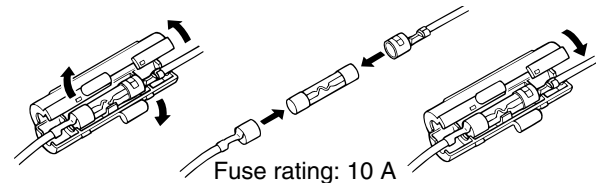

■ Cleaning

If the transceiver becomes dusty or dirty, wipe it clean with a soft, dry cloth.



AVOID the use of solvents such as benzene or alcohol, as they may damage transceiver surfaces.

■ Connections

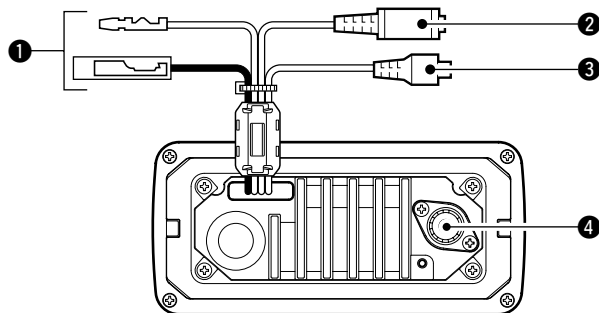

❶ DC POWER CONNECTOR

Connects the supplied DC power cable from this connector to an external 12 V battery.

❷ EXTERNAL SPEAKER JACK

Connects to an external speaker.

❸ GPS RECEIVER JACK

Connects to a GPS receiver for position indication.

- A NMEA0183 ver. 2.0 or 3.01 (sentence formatters RMC, GGA, GNS, GLL) compatible GPS receiver is required. Ask your dealer about suitable GPS receivers.

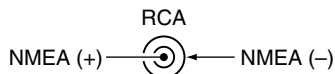

❹ ANTENNA CONNECTOR

Connects a marine VHF antenna with a PL-259 connector to the transceiver.

CAUTION: Transmitting without an antenna may damage the transceiver.

CAUTION: After connecting the DC power cable, GPS receiver jack and external speaker jack, cover the connector and jacks with an adhesive tape as shown below, to prevent water seeping into the transceiver.

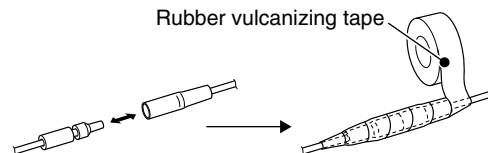

■ Mounting the transceiver

◆ Using the supplied mounting bracket

The universal mounting bracket supplied with your transceiver allows overhead or dashboard mounting.

- Mount the transceiver securely with the 2 supplied screws (5 × 20) to a surface which is more than 10 mm thick and can support more than 5 kg.
- Mount the transceiver so that the face of the transceiver is at 90° to your line of sight when operating it.

/// **CAUTION: KEEP** the transceiver and microphone at least 1 meter away from your vessel's magnetic navigation compass.

/// **NOTE:** Check the installation angle; the function display may not be easy-to-read at some angles.

EXAMPLE

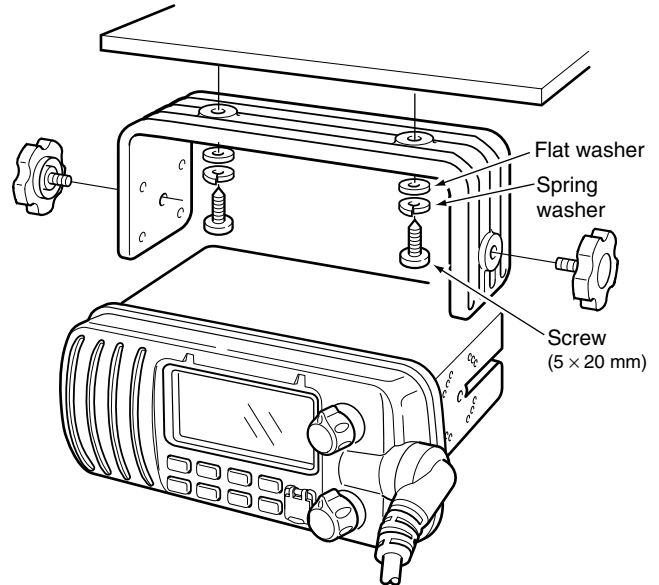

■ Optional MB-69 installation

An optional MB-69 FLUSH MOUNT is available for mounting the transceiver to a flat surface such as an instrument panel.

CAUTION: KEEP the transceiver and microphone at least 1 meter away from your vessel's magnetic navigation compass.

- ① Using the template on p. 55, carefully cut a hole into the instrument panel (or wherever you plan to mount the transceiver.)
- ② Slide the transceiver through the hole as shown below.

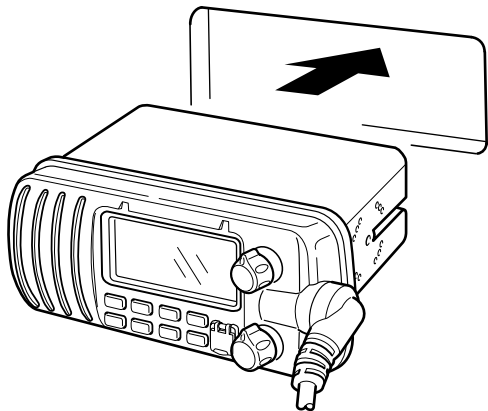

- ③ Attach the clamps on either side of the transceiver with 2 supplied bolts (5 × 8 mm).
 - Make sure that the clamps align parallel to the transceiver body.

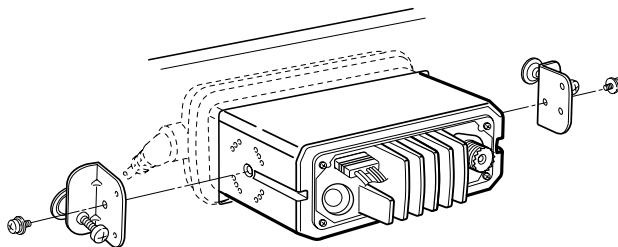

- ④ Tighten the end bolts on the clamps (rotate clockwise) so that the clamps press firmly against the inside of the instrument control panel.
- ⑤ Tighten the locking nuts (rotate counterclockwise) so that the transceiver is securely mounted in position as below.
- ⑥ Connect the antenna and power cable, then return the instrument control panel to its original place.

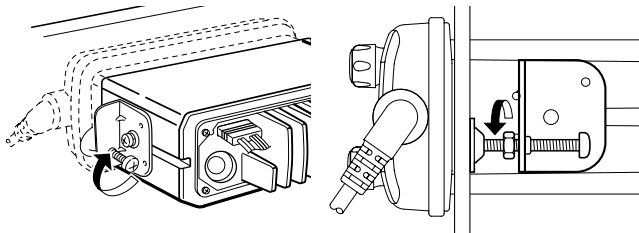

| PROBLEM | POSSIBLE CAUSE | SOLUTION | REF. |
|--|--|---|--------------------------------------|
| The transceiver does not turn ON. | <ul style="list-style-type: none"> • Bad connection to the power supply. | <ul style="list-style-type: none"> • Check the connection to the transceiver. | p. 48 |
| No sound from speaker. | <ul style="list-style-type: none"> • Squelch level is too high. • Volume level is too low. • Speaker has been exposed to water. | <ul style="list-style-type: none"> • Set squelch to the threshold point. • Set [VOL] to a suitable level. • Drain water from the speaker. | <p>p. 8</p> <p>p. 8</p> <p>—</p> |
| Transmitting is impossible, or high power can not be selected. | <ul style="list-style-type: none"> • Some channels are for low power or receive only. • The output power is set to low. | <ul style="list-style-type: none"> • Change channels. • Push [HI/LO] on the microphone to select high power. | <p>pgs. 6, 7, 52, 53</p> <p>p. 8</p> |
| Scan does not start. | <ul style="list-style-type: none"> • “TAG” channel is not programmed. | <ul style="list-style-type: none"> • Set the desired channels as “TAG” channels. | p. 13 |
| No beeps. | <ul style="list-style-type: none"> • Beep tones are turned OFF. • The squelch is open. | <ul style="list-style-type: none"> • Turn the beep tone ON in Set mode. • Set squelch to the threshold point. | <p>p. 46</p> <p>p. 8</p> |
| Distress call cannot be transmitted. | <ul style="list-style-type: none"> • MMSI (DSC self ID) code is not programmed. | <ul style="list-style-type: none"> • Program the MMSI (DSC self ID) code. | p. 14 |

10 CHANNEL LIST

• International channels

| CH | Frequency (MHz) | | CH | Frequency (MHz) | | CH | Frequency (MHz) | | CH | Frequency (MHz) | | CH | Frequency (MHz) | | CH | Frequency (MHz) | |
|----|-----------------|---------|------------------|-----------------|---------|-------------------|-----------------|---------|-----------------|-----------------|---------|------------------|-----------------|---------|------------------|-----------------|---------|
| | Transmit | Receive | | Transmit | Receive | | Transmit | Receive | | Transmit | Receive | | Transmit | Receive | | Transmit | Receive |
| 01 | 156.050 | 160.650 | 11 | 156.550 | 156.550 | 21 | 157.050 | 161.650 | 61 | 156.075 | 160.675 | 71 | 156.575 | 156.575 | 81 | 157.075 | 161.675 |
| 02 | 156.100 | 160.700 | 12 | 156.600 | 156.600 | 22 | 157.100 | 161.700 | 62 | 156.125 | 160.725 | 72 | 156.625 | 156.625 | 82 | 157.125 | 161.725 |
| 03 | 156.150 | 160.750 | 13 | 156.650 | 156.650 | 23 | 157.150 | 161.750 | 63 | 156.175 | 160.775 | 73 | 156.675 | 156.675 | 83 | 157.175 | 161.775 |
| 04 | 156.200 | 160.800 | 14 | 156.700 | 156.700 | 24 | 157.200 | 161.800 | 64 | 156.225 | 160.825 | 74 | 156.725 | 156.725 | 84 | 157.225 | 161.825 |
| 05 | 156.250 | 160.850 | 15 ^{*1} | 156.750 | 156.750 | 25 | 157.250 | 161.850 | 65 | 156.275 | 160.875 | 75 ^{*3} | 156.775 | 156.775 | 85 | 157.275 | 161.875 |
| 06 | 156.300 | 156.300 | 16 | 156.800 | 156.800 | 26 | 157.300 | 161.900 | 66 | 156.325 | 160.925 | 76 ^{*3} | 156.825 | 156.825 | 86 | 157.325 | 161.925 |
| 07 | 156.350 | 160.950 | 17 ^{*1} | 156.850 | 156.850 | 27 | 157.350 | 161.950 | 67 | 156.375 | 156.375 | 77 | 156.875 | 156.875 | 87 | 157.375 | 157.375 |
| 08 | 156.400 | 156.400 | 18 | 156.900 | 161.500 | 28 | 157.400 | 162.000 | 68 | 156.425 | 156.425 | 78 | 156.925 | 161.525 | 88 | 157.425 | 157.425 |
| 09 | 156.450 | 156.450 | 19 | 156.950 | 161.550 | 37A ^{*2} | 157.850 | 157.850 | 69 | 156.475 | 156.475 | 79 | 156.975 | 161.575 | P4 ^{*2} | 161.425 | 161.425 |
| 10 | 156.500 | 156.500 | 20 | 157.000 | 161.600 | 60 | 156.025 | 160.625 | 70 [†] | 156.525 | 156.525 | 80 | 157.025 | 161.625 | | | |

[†]Receive only

^{*1} Channels 15 and 17 may also be used for on-board communications provided the effective radiated power does not exceed 1W, and subject to the national regulations of the administration concerned when these channels are used in its territorial waters.

^{*2} UK Marina Channels: M1=37A (157.850 MHz), M2=P4 (161.425 MHz) for U.K. version only

^{*3} The use of these channels should be restricted to navigation-related communications only and all precautions should be taken to avoid harmful interference to channel 16, e.g. by limiting the output power to 1W or by means geographical separation.

• **USA channels** (for U.K. version only)

| CH | Frequency (MHz) | | CH | Frequency (MHz) | | CH | Frequency (MHz) | | CH | Frequency (MHz) | | CH | Frequency (MHz) | | CH | Frequency (MHz) | |
|-----|-----------------|---------|-----|-----------------|---------|------|-----------------|---------|-----|-----------------|---------|-----|-----------------|---------|-----|-----------------|---------|
| | Transmit | Receive | | Transmit | Receive | | Transmit | Receive | | Transmit | Receive | | Transmit | Receive | | Transmit | Receive |
| 01A | 156.050 | 156.050 | 12 | 156.600 | 156.600 | 22A | 157.100 | 157.100 | 64A | 156.225 | 156.225 | 77 | 156.875 | 156.875 | 86 | 157.325 | 161.925 |
| -- | --- | --- | 13† | 156.650 | 156.650 | 23A | 157.150 | 157.150 | 65A | 156.275 | 156.275 | 78A | 156.925 | 156.925 | 86A | 157.325 | 157.325 |
| 03A | 156.150 | 156.150 | 14 | 156.700 | 156.700 | 24 | 157.200 | 161.800 | 66A | 156.325 | 156.325 | 79A | 156.975 | 156.975 | 87 | 157.375 | 161.975 |
| -- | --- | --- | 15† | 156.750 | 156.750 | 25 | 157.250 | 161.850 | 67† | 156.375 | 156.375 | 80A | 157.025 | 157.025 | 87A | 157.375 | 157.375 |
| 05A | 156.250 | 156.250 | 16 | 156.800 | 156.800 | 26 | 157.300 | 161.900 | 68 | 156.425 | 156.425 | 81A | 157.075 | 157.075 | 88 | 157.425 | 162.025 |
| 06 | 156.300 | 156.300 | 17† | 156.850 | 156.850 | 27 | 157.350 | 161.950 | 69 | 156.475 | 156.475 | 82A | 157.125 | 157.125 | 88A | 157.425 | 157.425 |
| 07A | 156.350 | 156.350 | 18A | 156.900 | 156.900 | 28 | 157.400 | 162.000 | 70‡ | 156.525 | 156.525 | 83A | 157.175 | 157.175 | P4* | 161.425 | 161.425 |
| 08 | 156.400 | 156.400 | 19A | 156.950 | 156.950 | 37A* | 157.850 | 157.850 | 71 | 156.575 | 156.575 | 84 | 157.225 | 161.825 | | | |
| 09 | 156.450 | 156.450 | 20 | 157.000 | 161.600 | 61A | 156.075 | 156.075 | 72 | 156.625 | 156.625 | 84A | 157.225 | 157.225 | | | |
| 10 | 156.500 | 156.500 | 20A | 157.000 | 157.000 | -- | --- | --- | 73 | 156.675 | 156.675 | 85 | 157.275 | 161.875 | | | |
| 11 | 156.550 | 156.550 | 21A | 157.050 | 157.050 | 63A | 156.175 | 156.175 | 74 | 156.725 | 156.725 | 85A | 157.275 | 157.275 | | | |

† Low power only

‡ Receive only

*UK Marina Channels: M1=37A (157.850 MHz), M2=P4 (161.425 MHz) for U.K. version only

■ Specifications

Specifications are measured in accordance with EN301 025.

◇ General

- Frequency coverage :
 - Transmit 156.000–161.450 MHz
 - Receive 156.000–163.425 MHz
- Mode : FM (16K0G3E)
DSC (16K0G2B)
- Current drain (at 13.8 V) : TX high (25 W) 5.5 A
Max. audio 1.5 A
- Power supply requirement : 13.8 V DC (10.8 to 15.6 V)
(negative ground)
- Frequency stability : ± 1.5 kHz (-20°C to $+60^{\circ}\text{C}$)
- Antenna connector : SO-239 (50 Ω)
- Input impedance (MIC) : 2 k Ω
- Output impedance (audio) : 4 Ω
- Dimensions : 164(W) \times 78(H) \times 139.5(D) mm
(Projection not included)
- Weight : Approx. 1150 g

◇ Transmitter

- RF output power : 25 W and 1 W
- Modulation system : Variable reactance frequency modulation
- Max. frequency deviation : ± 5.0 kHz
- Spurious emissions : Less than 0.25 μW
- Residual modulation : More than 40 dB
- Audio harmonic distortion : Less than 10%
(at 1 kHz, 60% deviation)

◇ Receiver

- Receive system : Double conversion
superheterodyne
- Sensitivity (20 dB SINAD) : -2 dB μ emf typical
(CH 70 receiver) -2 dB μ emf typical
- Squelch sensitivity : Less than 0 dB μ emf
- Spurious response : More than 70 dB
- Intermodulation : More than 68 dB
- Adjacent channel selectivity : More than 70 dB
- Hum and noise : More than 40 dB
- Audio output power : More than 2 W

All stated specifications are subject to change without notice or obligation.

■ Option

- **MB-69 FLUSH MOUNT** (p. 50)

For mounting the transceiver to a panel.

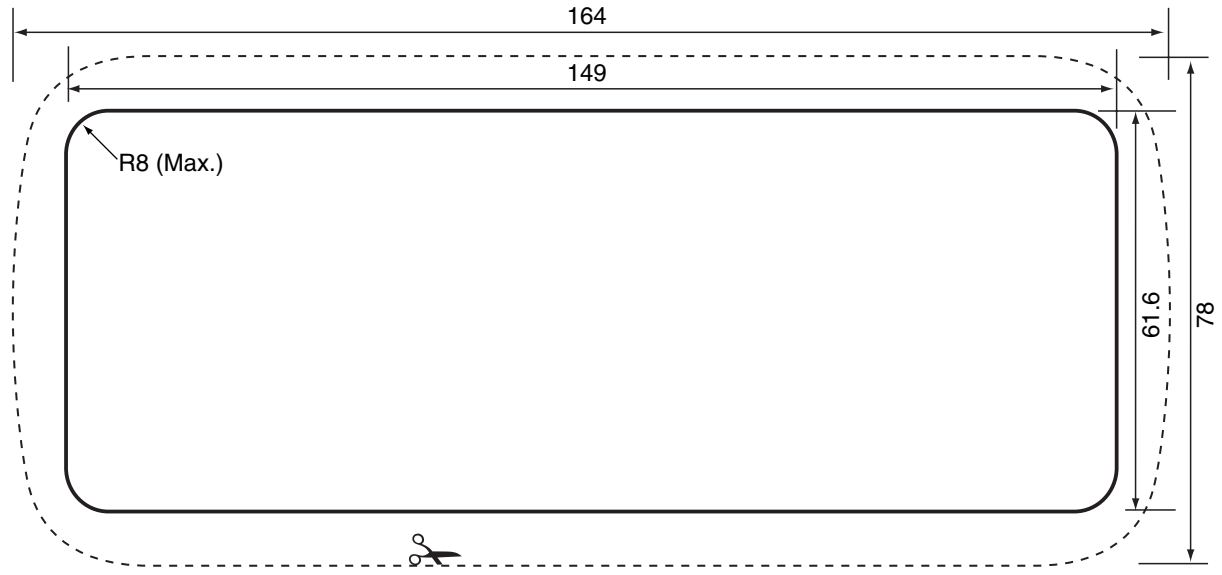

Unit: mm

Cut here

11
12

Dimensions

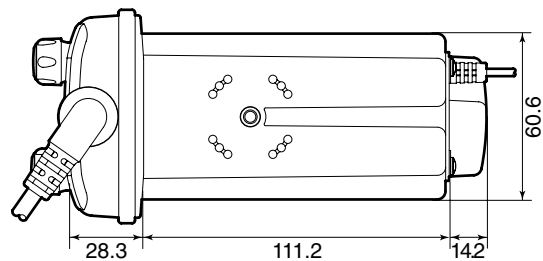
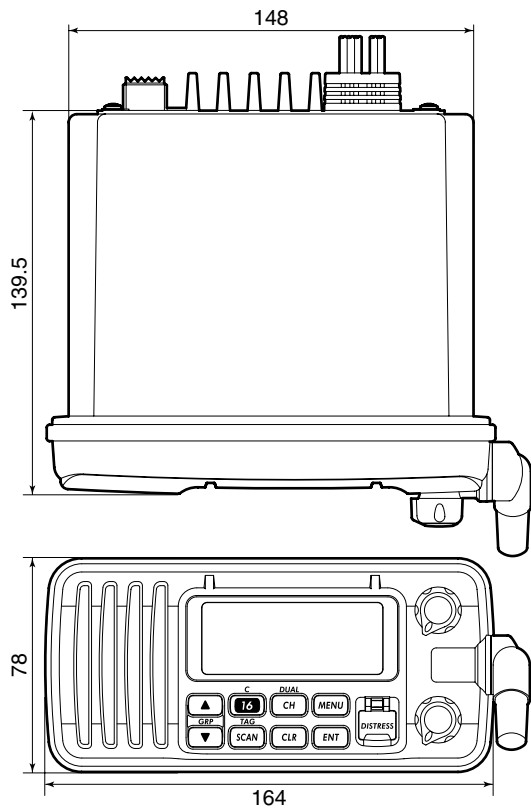

Unit: mm

Count on us!

< Intended Country of Use >

- GER FRA ESP SWE
 AUT NED POR DEN
 GBR BEL ITA FIN
 IRL LUX GRE SUI
 NOR