

DATA SHEET

BLW76 HF/VHF power transistor

Product specification

August 1986

HF/VHF power transistor

BLW76

DESCRIPTION

N-P-N silicon planar epitaxial transistor intended for use in class-AB or class-B operated high power transmitters in the h.f. and v.h.f. bands. The transistor presents excellent performance as a linear amplifier in the h.f. band. It is resistance stabilized and is guaranteed to withstand severe load

mismatch conditions. Transistors are delivered in matched h_{FE} groups.

The transistor has a 1/2" flange envelope with a ceramic cap. All leads are isolated from the flange.

QUICK REFERENCE DATA

R.F. performance up to $T_h = 25\text{ }^\circ\text{C}$

MODE OF OPERATION	V_{CE} V	$I_{C(zs)}$ A	f MHz	P_L W	G_p dB	η %	d_3 dB
s.s.b. (class-AB)	28	0,05	1,6 – 28	8 – 80 (P.E.P.)	> 13	> 35 ⁽¹⁾	< -30
c.w. (class-B)	28	–	108	80	typ. 7,9	typ. 70	–

Note

- At 80 W P.E.P.

PIN CONFIGURATION

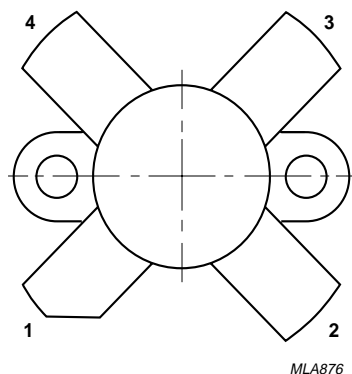

Fig.1 Simplified outline. SOT121B.

PINNING - SOT121B.

PIN	DESCRIPTION
1	collector
2	emitter
3	base
4	emitter

PRODUCT SAFETY This device incorporates beryllium oxide, the dust of which is toxic. The device is entirely safe provided that the BeO disc is not damaged.

HF/VHF power transistor

BLW76

RATINGS

Limiting values in accordance with the Absolute Maximum System (IEC 134)

Collector-emitter voltage ($V_{BE} = 0$)

peak value

V_{CESM} max. 70 V

Collector-emitter voltage (open base)

V_{CEO} max. 35 V

Emitter-base voltage (open collector)

V_{EBO} max. 4 V

Collector current (average)

$I_{C(AV)}$ max. 8 A

Collector current (peak value); $f > 1$ MHz

I_{CM} max. 20 A

R.F. power dissipation ($f > 1$ MHz); $T_{mb} = 25$ °C

P_{rf} max. 140 W

Storage temperature

T_{stg} -65 to + 150 °C

Operating junction temperature

T_j max. 200 °C

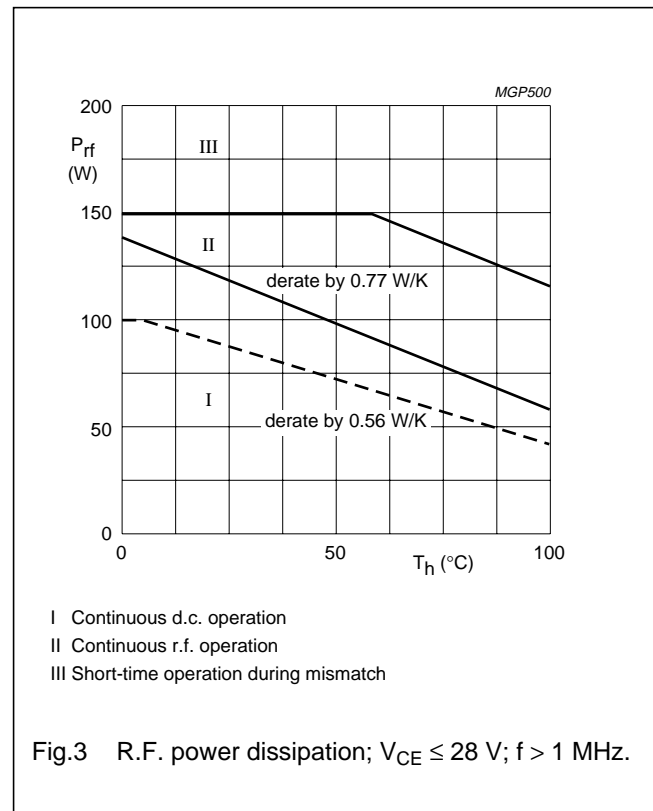
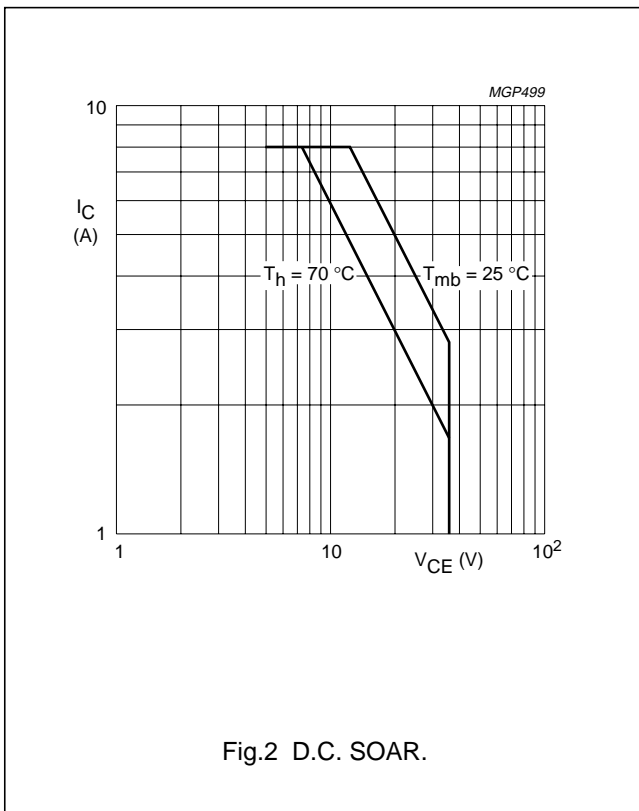

THERMAL RESISTANCE

(dissipation = 60 W; $T_{mb} = 82$ °C, i.e. $T_h = 70$ °C)

From junction to mounting base (d.c. dissipation)

$R_{th\ j-mb(dc)}$ = 1,92 K/W

From junction to mounting base (r.f. dissipation)

$R_{th\ j-mb(rf)}$ = 1,33 K/W

From mounting base to heatsink

$R_{th\ mb-h}$ = 0,2 K/W

HF/VHF power transistor

BLW76

CHARACTERISTICS

$T_j = 25\text{ }^\circ\text{C}$ unless otherwise specified

Collector-emitter breakdown voltage

$V_{BE} = 0; I_C = 50\text{ mA}$

$V_{(BR)CES} > 70\text{ V}$

Collector-emitter breakdown voltage

open base; $I_C = 50\text{ mA}$

$V_{(BR)CEO} > 35\text{ V}$

Emitter-base breakdown voltage

open collector; $I_E = 10\text{ mA}$

$V_{(BR)EBO} > 4\text{ V}$

Collector cut-off current

$V_{BE} = 0; V_{CE} = 35\text{ V}$

$I_{CES} < 10\text{ mA}$

D.C. current gain⁽¹⁾

$I_C = 4\text{ A}; V_{CE} = 5\text{ V}$

$h_{FE} \quad 15\text{ to }80$

D.C. current gain ratio of matched devices⁽¹⁾

$I_C = 4\text{ A}; V_{CE} = 5\text{ V}$

$h_{FE1}/h_{FE2} < 1,2$

Collector-emitter saturation voltage⁽¹⁾

$I_C = 12,5\text{ A}; I_B = 2,5\text{ A}$

$V_{CEsat} \text{ typ. } 2,5\text{ V}$

Transition frequency at $f = 100\text{ MHz}$ ⁽²⁾

$-I_E = 4\text{ A}; V_{CB} = 28\text{ V}$

$f_T \text{ typ. } 315\text{ MHz}$

$-I_E = 12,5\text{ A}; V_{CB} = 28\text{ V}$

$f_T \text{ typ. } 305\text{ MHz}$

Collector capacitance at $f = 1\text{ MHz}$

$I_E = I_e = 0; V_{CB} = 28\text{ V}$

$C_c \text{ typ. } 125\text{ pF}$

Feedback capacitance at $f = 1\text{ MHz}$

$I_C = 50\text{ mA}; V_{CE} = 28\text{ V}$

$C_{re} \text{ typ. } 85\text{ pF}$

Collector-flange capacitance

$C_{cf} \text{ typ. } 3\text{ pF}$

Notes

1. Measured under pulse conditions: $t_p \leq 300\text{ }\mu\text{s}; \delta \leq 0,02$.
2. Measured under pulse conditions: $t_p \leq 50\text{ }\mu\text{s}; \delta \leq 0,01$.

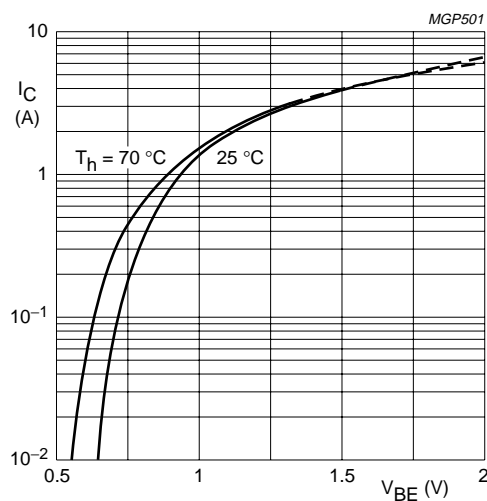
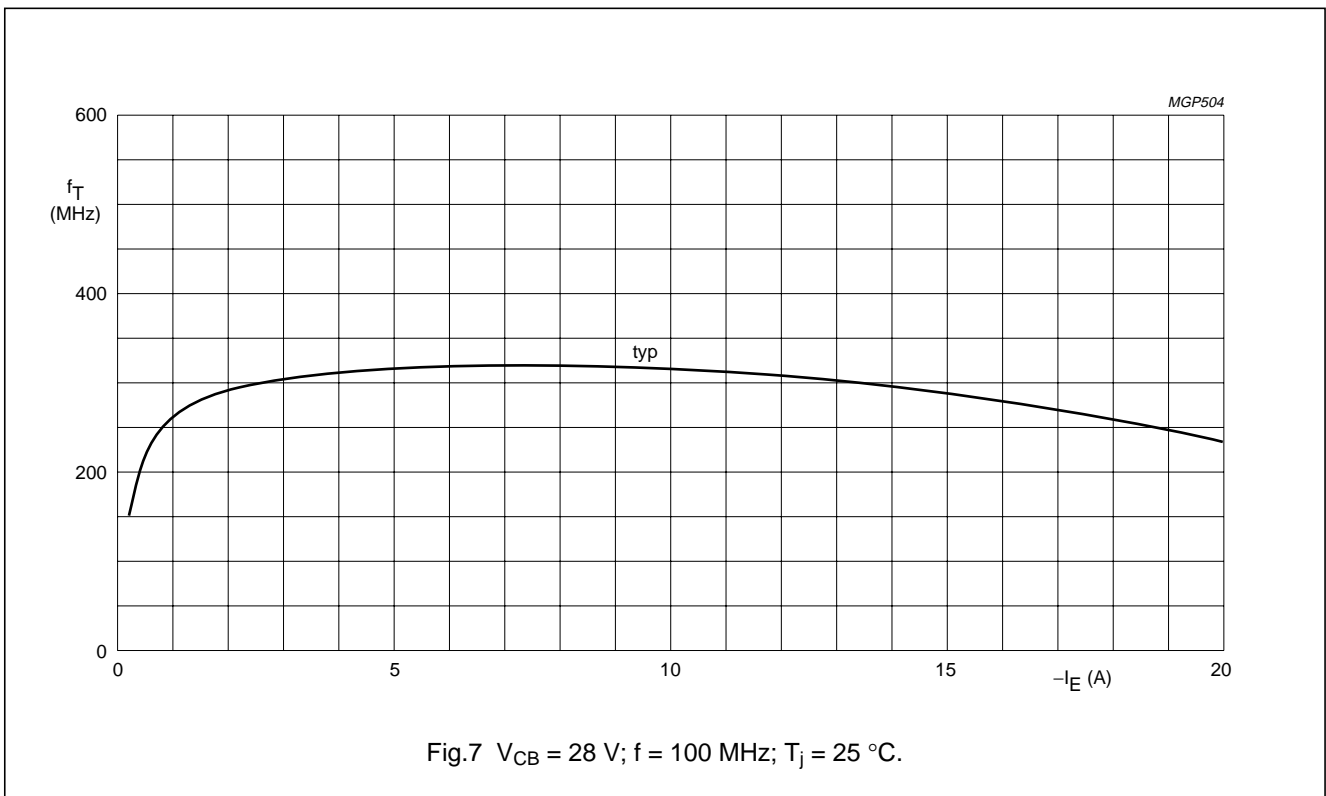
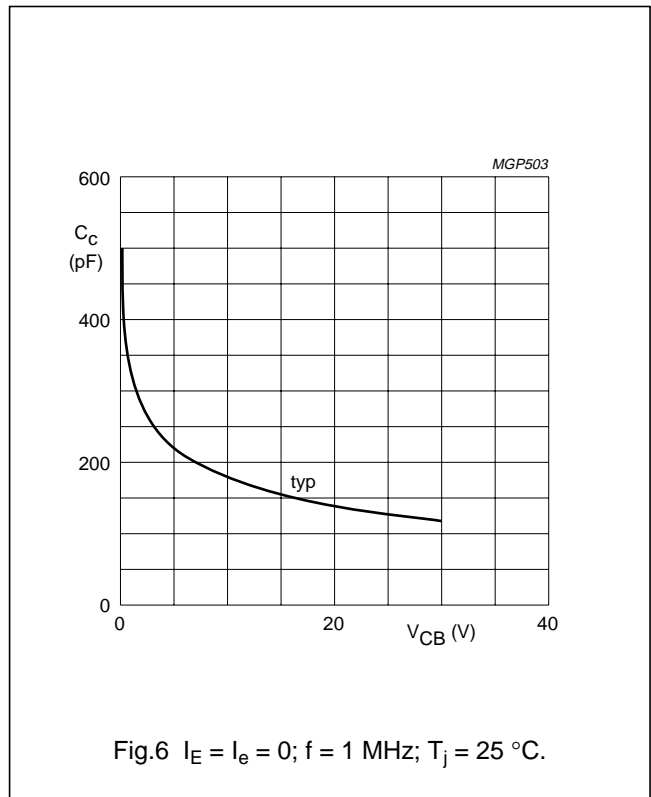
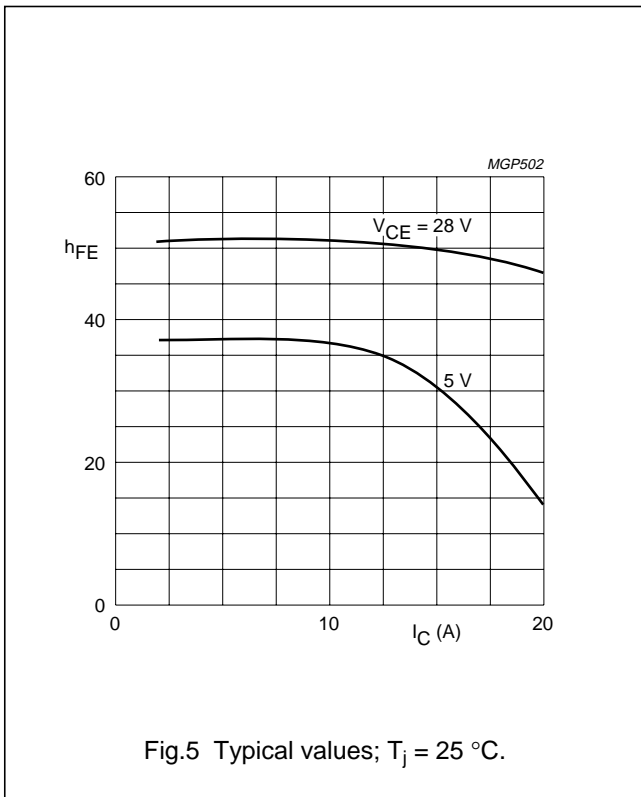

Fig.4 Typical values; $V_{CE} = 20\text{ V}$.

HF/VHF power transistor

BLW76



HF/VHF power transistor

BLW76

APPLICATION INFORMATION

R.F. performance in s.s.b. class-AB operation (linear power amplifier)

$V_{CE} = 28 \text{ V}$; $T_h = 25 \text{ }^\circ\text{C}$; $f_1 = 28,000 \text{ MHz}$; $f_2 = 28,001 \text{ MHz}$

OUTPUT POWER W	G_p dB	η_{dt} (%) at 80 W P.E.P.	I_c (A) < 4,1	d_3 dB	d_5 dB	$I_{c(zs)}$ A
8 to 80 (P.E.P.)	> 13	> 35	< 4,1	< -30	< -30	0,05

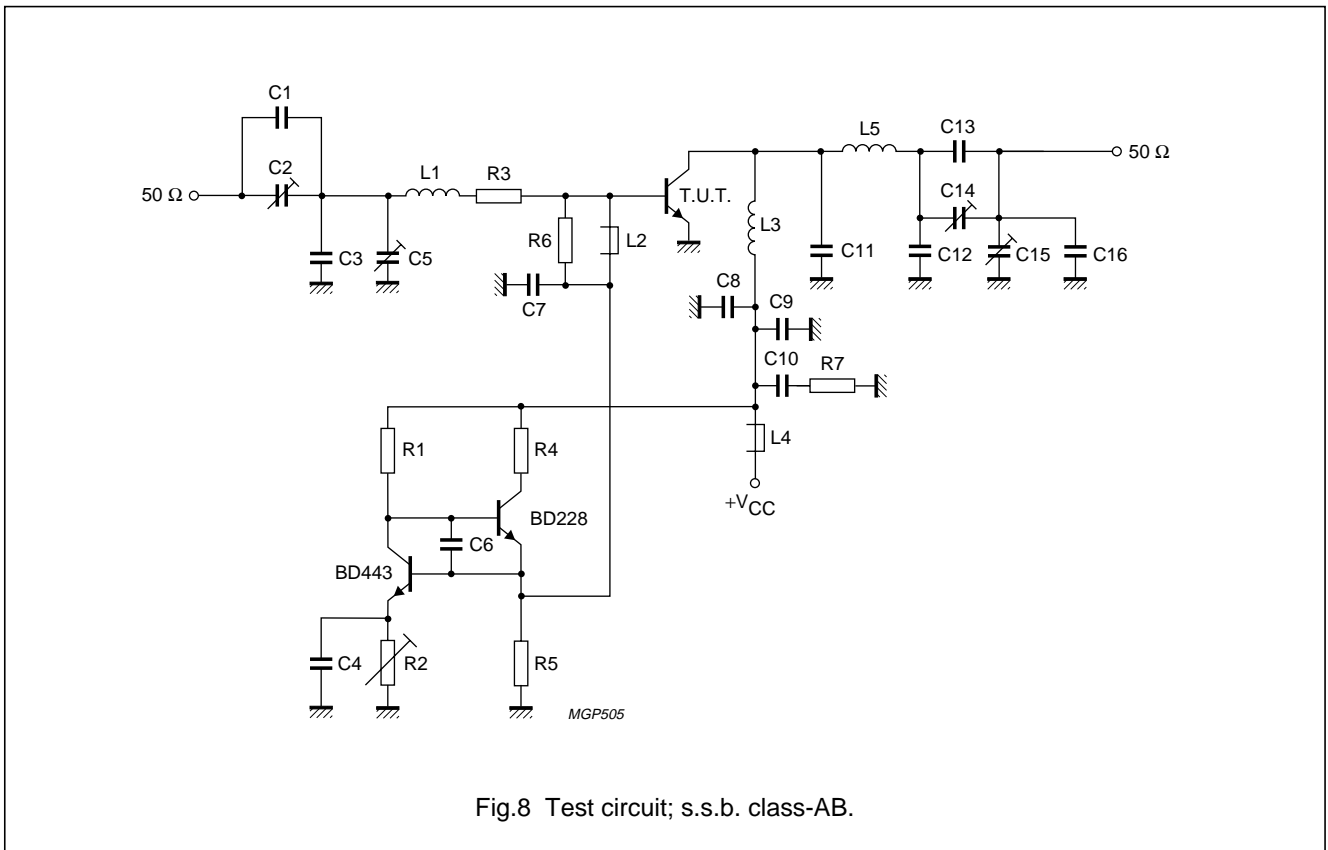

HF/VHF power transistor**BLW76**

List of components:

- C1 = 27 pF ceramic capacitor (500 V)
- C2 = 100 pF air dielectric trimmer (single insulated rotor type)
- C3 = 100 pF polystyrene capacitor
- C4 = C6 = C9 = 100 nF polyester capacitor
- C5 = 280 pF air dielectric trimmer (single non-insulated rotor type)
- C7 = C8 = 3,9 nF ceramic capacitor
- C10 = 2,2 μ F moulded metallized polyester capacitor
- C11 = 180 pF polystyrene capacitor
- C12 = 2 \times 68 pF ceramic capacitors in parallel (500 V)
- C13 = 120 pF polystyrene capacitor
- C14 = C15 = 280 pF air dielectric trimmer (single insulated rotor type)
- C16 = 56 pF ceramic capacitor (500 V)
- L1 = 108 nH; 4 turns Cu wire (1,6 mm); int. dia. 8,7 mm; length 11,2 mm; leads 2 \times 7 mm
- L2 = L4 = Ferroxcube wide-band h.f. choke, grade 3B (cat. no. 4312 020 36640)
- L3 = 88 nH; 3 turns Cu wire (1,6 mm); int. dia. 8,0 mm; length 8,0 mm; leads 2 \times 7 mm
- L5 = 120 nH; 4 turns Cu wire (1,6 mm); int. dia. 9,3 mm; length 11,2 mm; leads 2 \times 7 mm
- R1 = 1,5 k Ω (\pm 5%) carbon resistor (0,5 W)
- R2 = 10 Ω wirewound potentiometer (3 W)
- R3 = 0,9 Ω ; parallel connection of 2 \times 1,8 Ω carbon resistors (\pm 5%; 0,5 W each)
- R4 = 60 Ω ; parallel connection of 2 \times 120 Ω wirewound resistors (5,5 W each)
- R5 = 56 Ω (\pm 5%) carbon resistor (0,5 W)
- R6 = 33 Ω (\pm 5%) carbon resistor (0,5 W)
- R7 = 4,7 Ω (\pm 5%) carbon resistor (0,5 W)

HF/VHF power transistor

BLW76

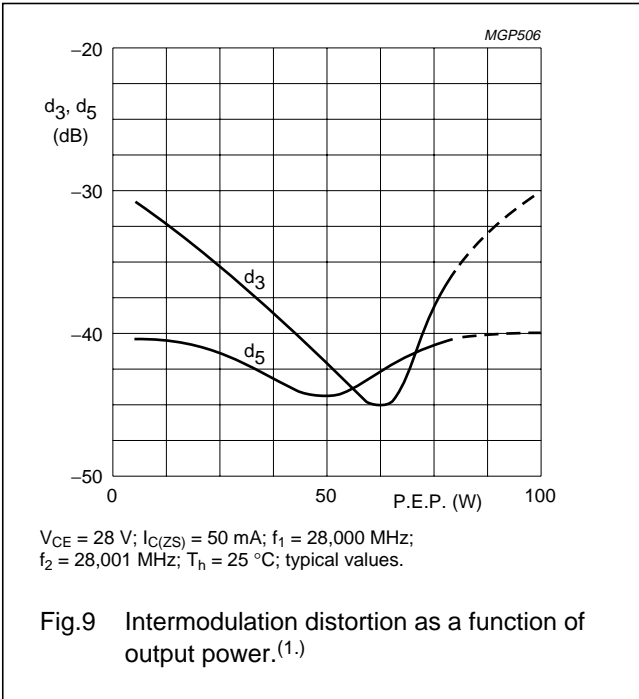

1. Stated intermodulation distortion figures are referred to the according level of either of the equal amplified tones. Relative to the according peak envelope powers these figures should be increased by 6 dB.

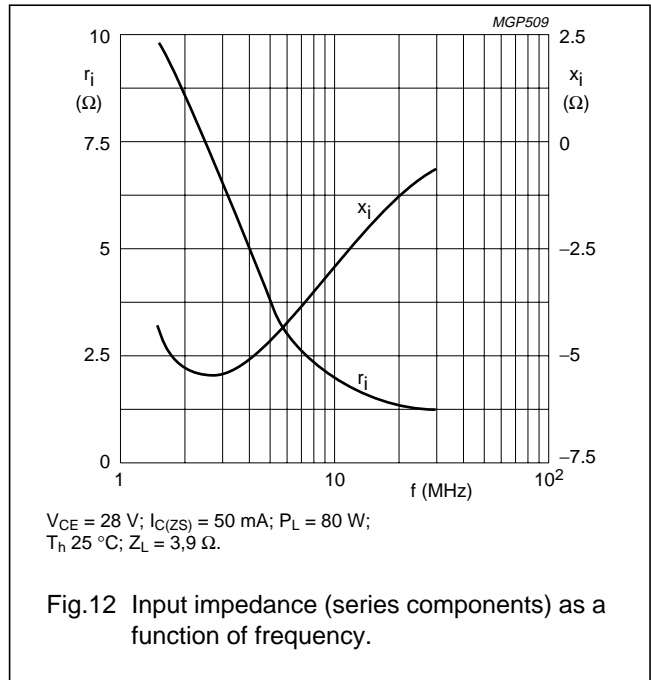
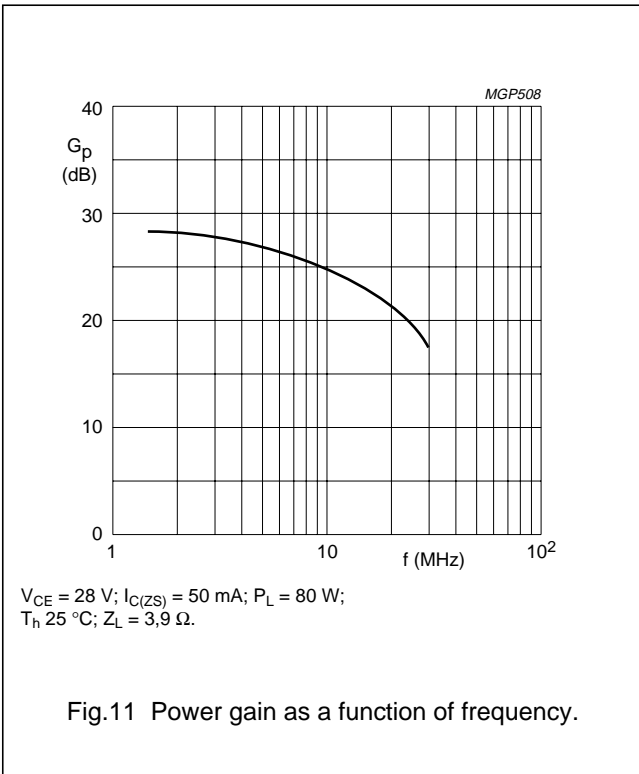
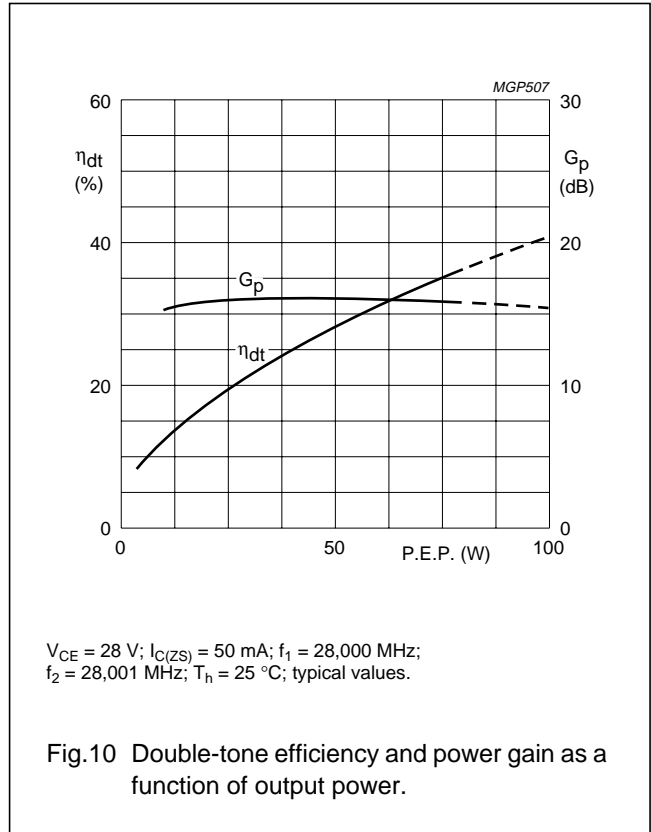

Figs 11 and 12 are typical curves and hold for an unneutralized amplifier in s.s.b. class-AB operation.

HF/VHF power transistor

BLW76

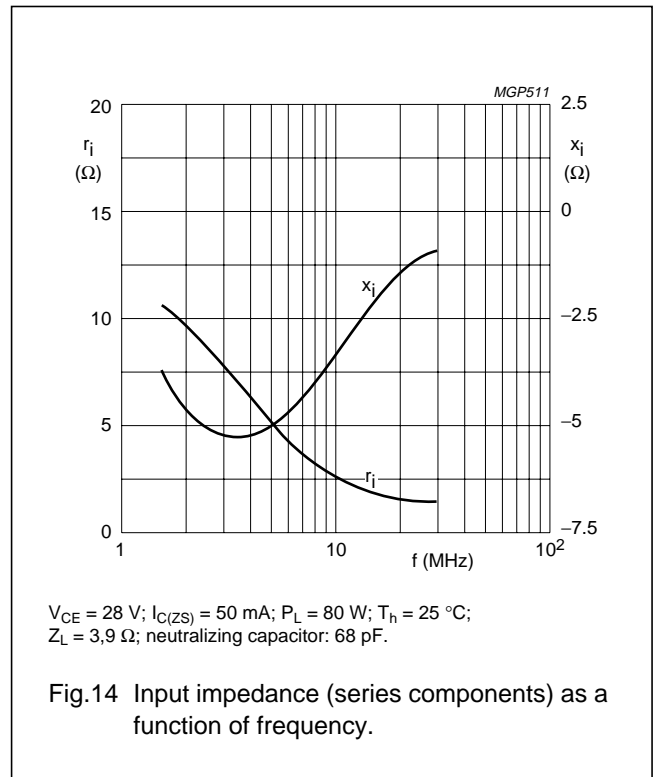
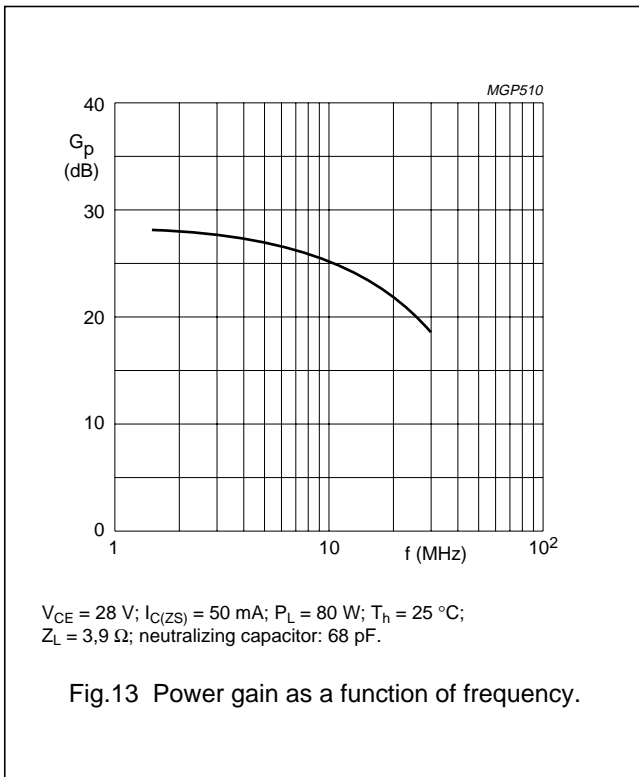

Figs 13 and 14 are typical curves and hold for a push-pull amplifier with cross-neutralization in s.s.b. class-AB operation.

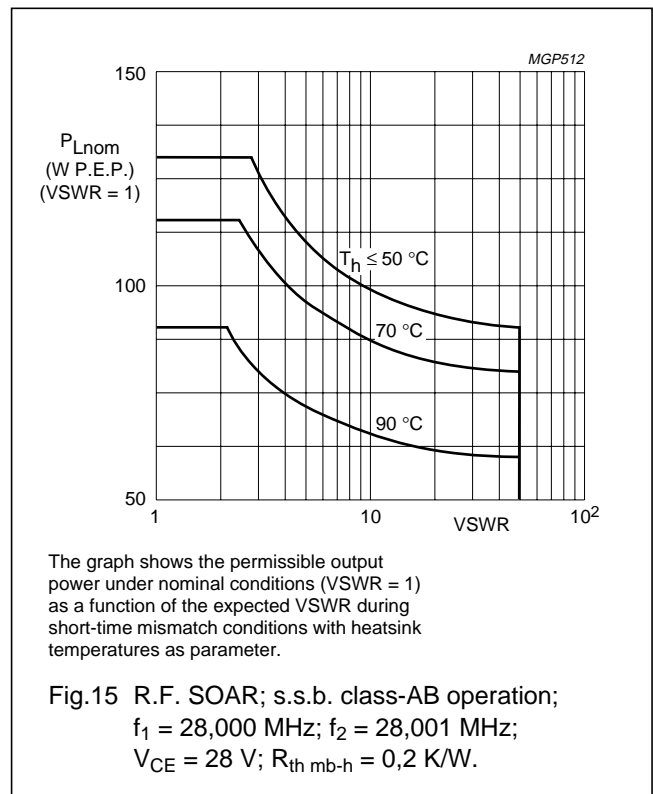

HF/VHF power transistor

BLW76

R.F. performance in c.w. operation (unneutralized common-emitter class-B circuit); $T_h = 25\text{ }^\circ\text{C}$

f (MHz)	V_{CE} (V)	P_L (W)	P_S (W)	G_p (dB)	I_c (A)	η (%)	\bar{z}_i (Ω)	\bar{Y}_L (mS)
108	28	80	typ. 13	typ. 7,9	typ. 4,1	typ. 70	$0,85 + j1,0$	$174 - j40$

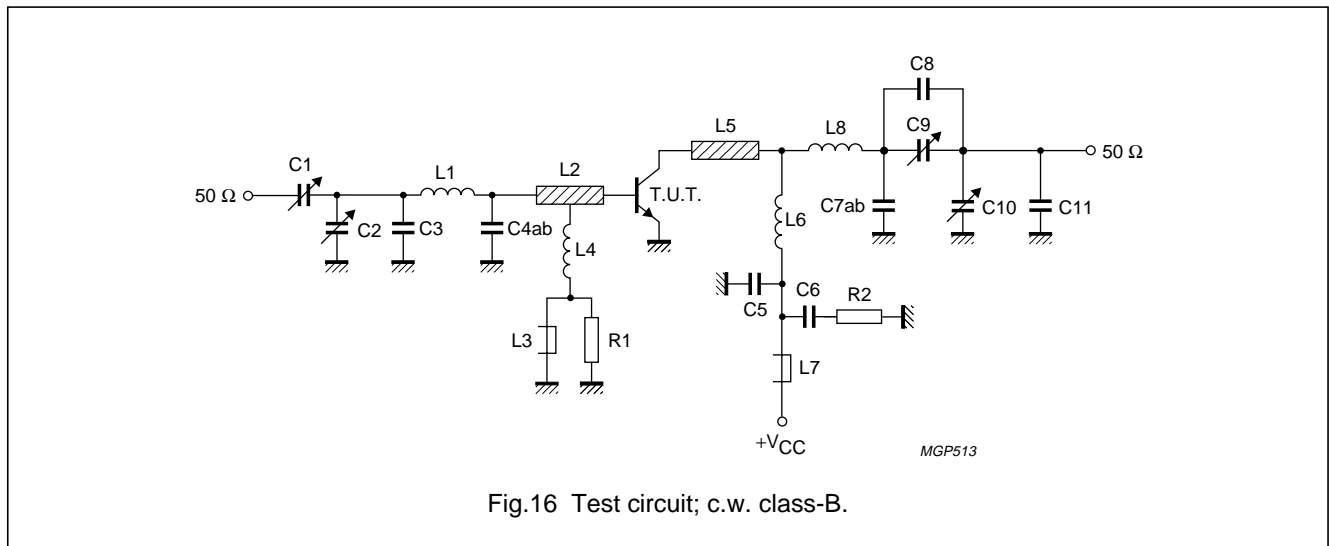

Fig.16 Test circuit; c.w. class-B.

List of components:

- C1 = C9 = C10 = 4 to 40 pF film dielectric trimmer (cat. no. 2222 809 07008)
 - C2 = 5 to 60 pF film dielectric trimmer (cat. no. 2222 809 07011)
 - C3 = 22 pF ceramic capacitor (500 V)
 - C4ab = 2×82 pF ceramic capacitors in parallel (500 V)
 - C5 = 270 pF polystyrene capacitor
 - C6 = 100 nF polyester capacitor
 - C7a = 8,2 pF ceramic capacitor (500 V)
 - C7b = 10 pF ceramic capacitor (500 V)
 - C8 = 5,6 pF ceramic capacitor (500 V)
 - C11 = 10 pF ceramic capacitor (500 V)
 - L1 = 21 nH; 2 turns Cu wire (1,0 mm); int. dia. 4,0 mm; length 3,5 mm; leads 2×5 mm
 - L2 = L5 = 2,4 nH; strip (12 mm \times 6 mm); tap for L4 at 6 mm from transistor
 - L3 = L7 = Ferroxcube wide-band h.f. choke, grade 3B (cat. no. 4312 020 36640)
 - L4 = 100 nH; 7 turns closely wound enamelled Cu wire (0,5 mm); int. dia. 3 mm; leads 2×5 mm
 - L6 = 49 nH; 2 turns Cu wire (1,6 mm); int. dia. 9,0 mm; length 4,7 mm; leads 2×5 mm
 - L8 = 56 nH; 2 turns Cu wire (1,6 mm); int. dia. 10,0 mm; length 4,5 mm; leads 2×5 mm
- L2 and L5 are strips on a double Cu-clad printed-circuit board with epoxy fibre-glass dielectric.
- R1 = R2 = 10 Ω ($\pm 10\%$) carbon resistor

Component layout and printed-circuit board for 108 MHz test circuit are shown in Fig.17.

HF/VHF power transistor

BLW76

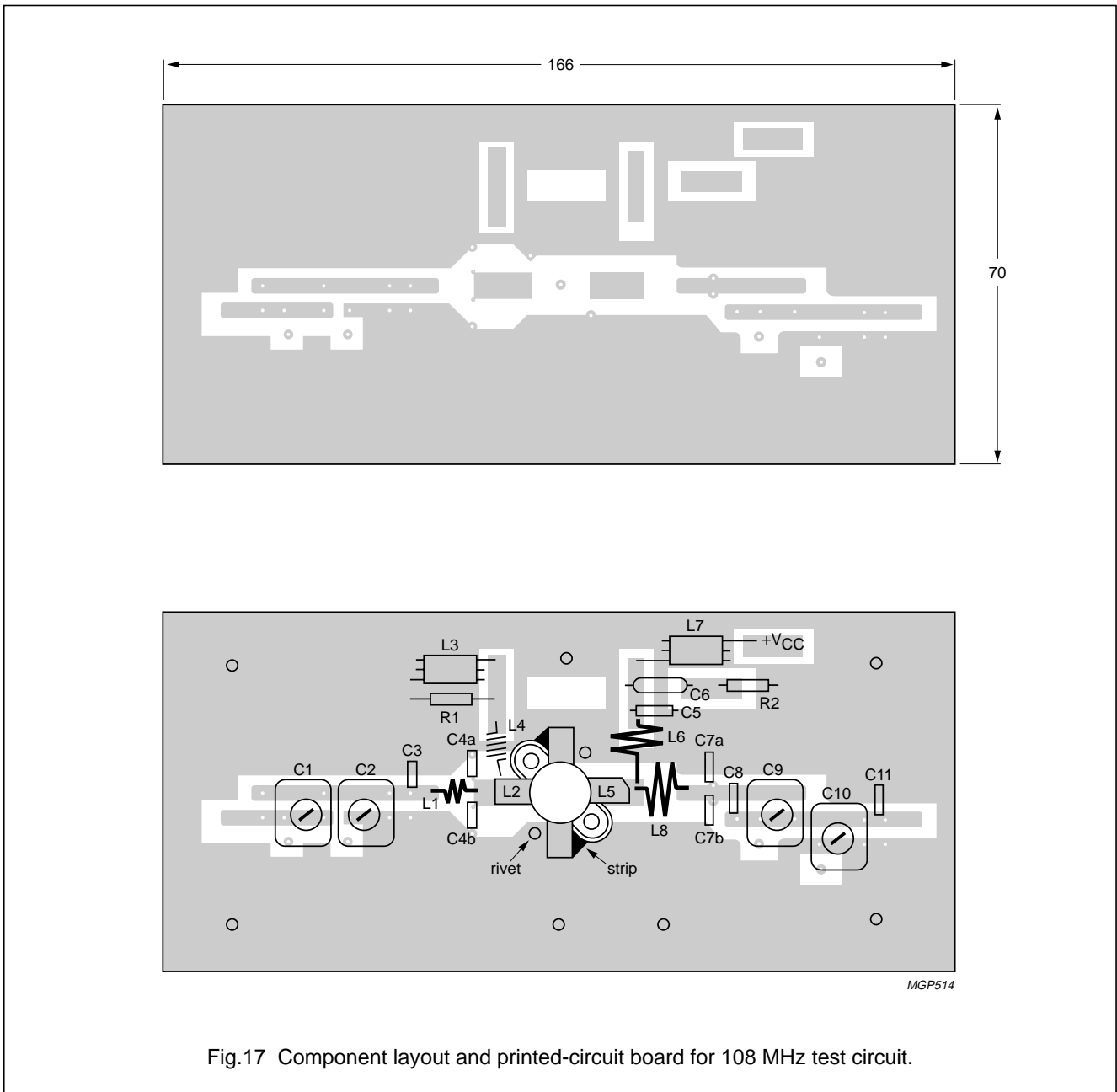

The circuit and the components are situated on one side of the epoxy fibre-glass board, the other side being fully metallized to serve as earth. Earth connections are made by means of hollow rivets, whilst under the emitter leads Cu straps are used for a direct contact between upper and lower sheets.

HF/VHF power transistor

BLW76

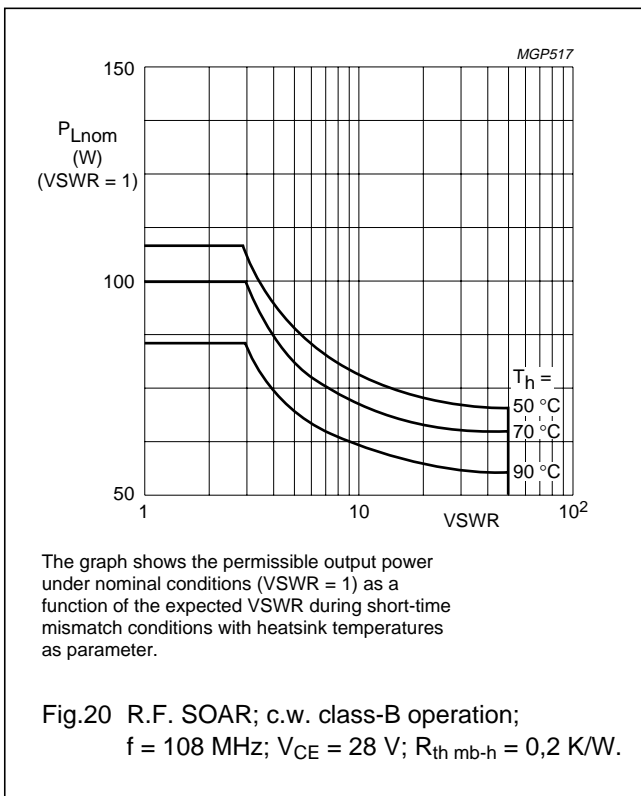
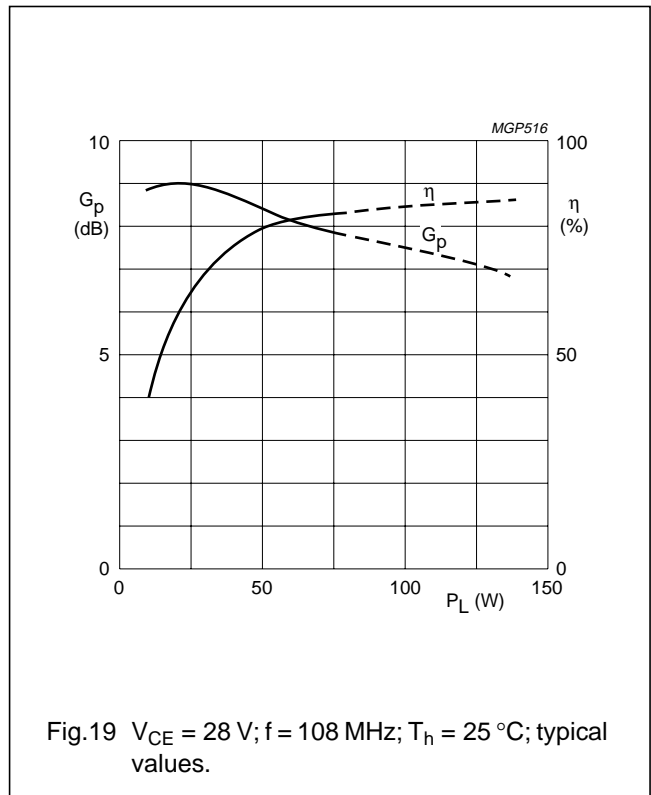
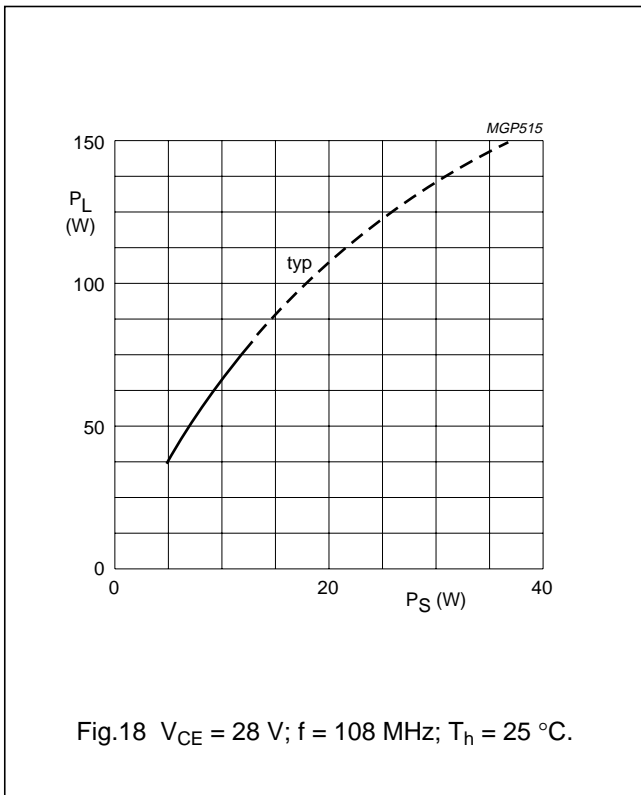

HF/VHF power transistor

BLW76

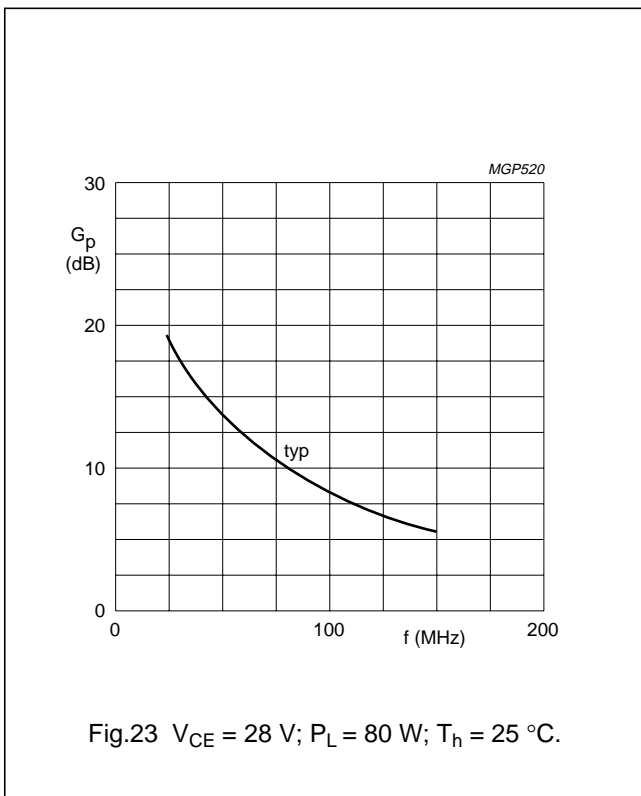
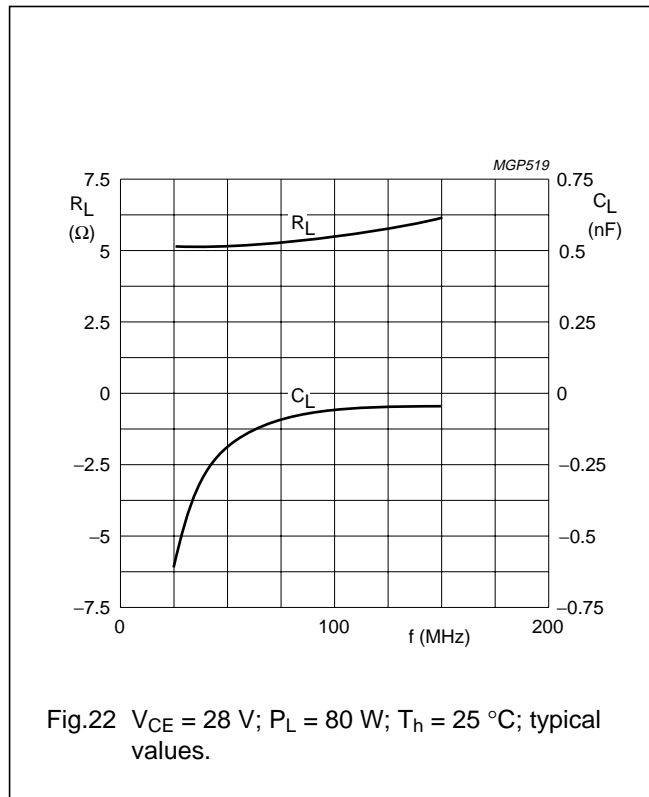
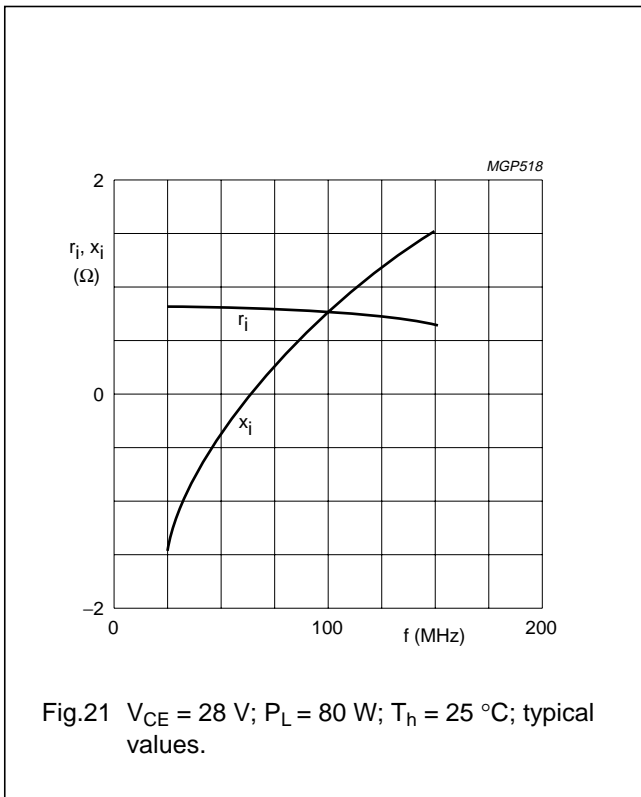

HF/VHF power transistor

BLW76

PACKAGE OUTLINE

Flanged ceramic package; 2 mounting holes; 4 leads

SOT121B

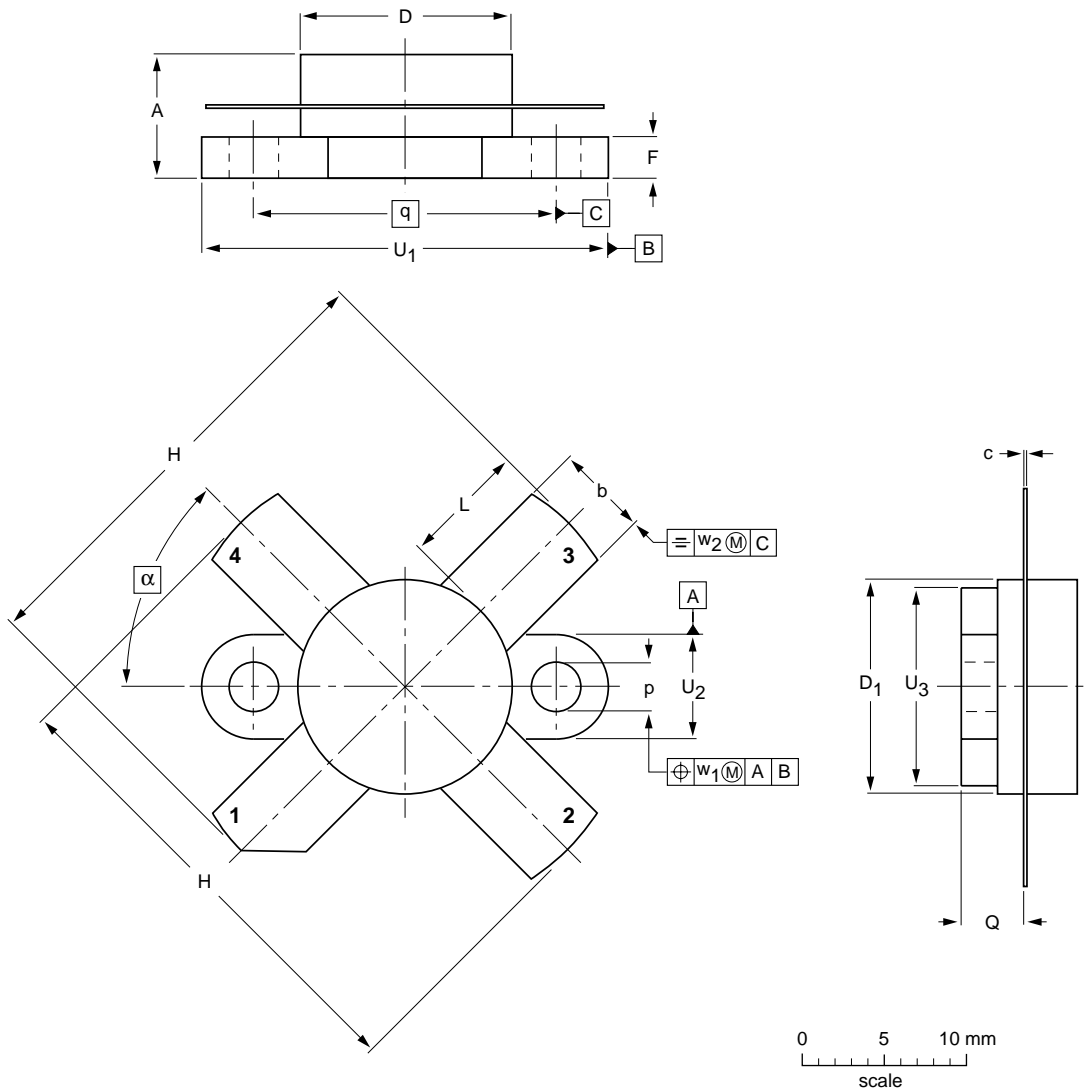

DIMENSIONS (millimetre dimensions are derived from the original inch dimensions)

UNIT	A	b	c	D	D ₁	F	H	L	p	Q	q	U ₁	U ₂	U ₃	w ₁	w ₂	α
mm	7.27 6.17	5.82 5.56	0.16 0.10	12.86 12.59	12.83 12.57	2.67 2.41	28.45 25.52	7.93 6.32	3.30 3.05	4.45 3.91	18.42	24.90 24.63	6.48 6.22	12.32 12.06	0.51	1.02	45°
inches	0.286 0.243	0.229 0.219	0.006 0.004	0.506 0.496	0.505 0.495	0.105 0.095	1.120 1.005	0.312 0.249	0.130 0.120	0.175 0.154	0.725	0.98 0.97	0.255 0.245	0.485 0.475	0.02	0.04	

OUTLINE VERSION	REFERENCES				EUROPEAN PROJECTION	ISSUE DATE
	IEC	JEDEC	EIAJ			
SOT121B						97-06-28

HF/VHF power transistor

BLW76

DEFINITIONS

Data Sheet Status	
Objective specification	This data sheet contains target or goal specifications for product development.
Preliminary specification	This data sheet contains preliminary data; supplementary data may be published later.
Product specification	This data sheet contains final product specifications.
Limiting values	
Limiting values given are in accordance with the Absolute Maximum Rating System (IEC 134). Stress above one or more of the limiting values may cause permanent damage to the device. These are stress ratings only and operation of the device at these or at any other conditions above those given in the Characteristics sections of the specification is not implied. Exposure to limiting values for extended periods may affect device reliability.	
Application information	
Where application information is given, it is advisory and does not form part of the specification.	

LIFE SUPPORT APPLICATIONS

These products are not designed for use in life support appliances, devices, or systems where malfunction of these products can reasonably be expected to result in personal injury. Philips customers using or selling these products for use in such applications do so at their own risk and agree to fully indemnify Philips for any damages resulting from such improper use or sale.