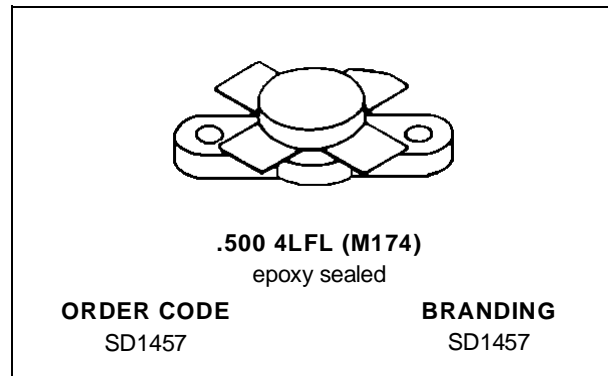

**RF & MICROWAVE TRANSISTORS
FM BROADCAST APPLICATIONS**

- 108 MHz
- 28 VOLTS
- EFFICIENCY 75%
- COMMON EMITTER
- GOLD METALLIZATION
- $P_{OUT} = 75 \text{ W MIN. WITH } 10.0 \text{ dB GAIN}$

DESCRIPTION

The SD1457 is a 28 V gold metallized epitaxial silicon NPN planar transistor designed for FM VHF broadcast transmitters.

This device utilizes diffused emitter resistors to achieve infinite VSWR at rated operating conditions.

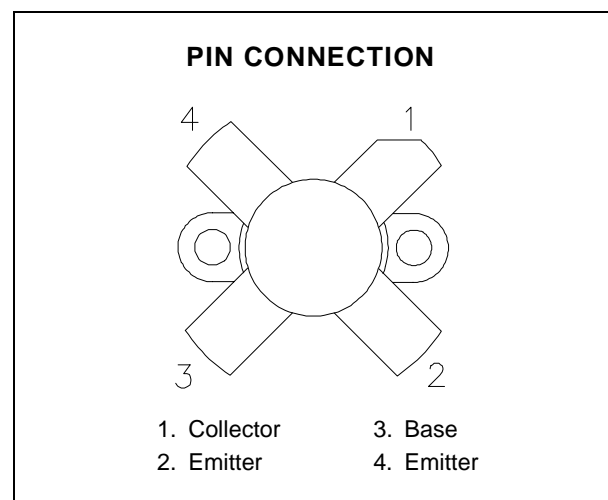
ABSOLUTE MAXIMUM RATINGS ($T_{case} = 25^{\circ}\text{C}$)

Symbol	Parameter	Value	Unit
V_{CBO}	Collector-Base Voltage	65	V
V_{CEO}	Collector-Emitter Voltage	30	V
V_{CES}	Collector-Emitter Voltage	60	V
V_{EBO}	Emitter-Base Voltage	4.0	V
I_C	Device Current	10	A
P_{DISS}	Power Dissipation	100	W
T_J	Junction Temperature	+200	$^{\circ}\text{C}$
T_{STG}	Storage Temperature	- 65 to +150	$^{\circ}\text{C}$

THERMAL DATA

$R_{TH(j-c)}$	Junction-Case Thermal Resistance	1.5	$^{\circ}\text{C/W}$
---------------	----------------------------------	-----	----------------------

SD1457

ELECTRICAL SPECIFICATIONS (T_{case} = 25°C)

STATIC

Symbol	Test Conditions		Value			Unit
			Min.	Typ.	Max.	
BV _{CBO}	I _C = 50mA	I _E = 0mA	65	—	—	V
BV _{CER}	I _C = 50mA	R _{BE} = 10Ω	60	—	—	V
BV _{CEO}	I _C = 50mA	I _B = 0mA	30	—	—	V
BV _{EBO}	I _E = 10mA	I _C = 0mA	4.0	—	—	V
h _{FE}	V _{CE} = 5V	I _C = 1A	20	—	150	—

DYNAMIC

Symbol	Test Conditions			Value			Unit
				Min.	Typ.	Max.	
P _{OUT}	f = 108 MHz	P _{IN} = 7.5 W	V _{CE} = 28 V	75	—	—	W
G _P	f = 108 MHz	P _{IN} = 7.5 W	V _{CE} = 28 V	10	—	—	dB
η _C	f = 108 MHz	P _{IN} = 7.5 W	V _{CE} = 28 V	70	—	—	%
C _{OB}	f = 1 MHz	V _{CB} = 30 V		—	—	85	pF

TYPICAL PERFORMANCE

POWER OUTPUT vs POWER INPUT

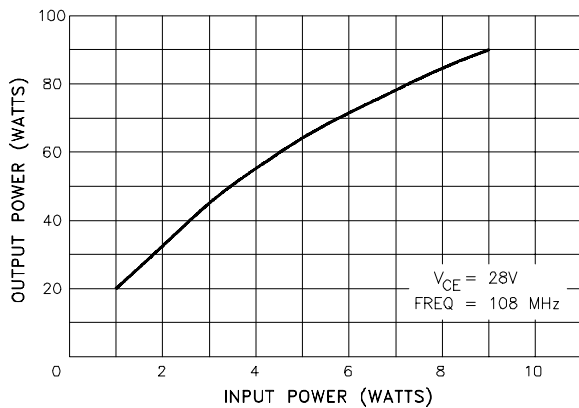

THERMAL RESISTANCE vs CASE TEMPERATURE

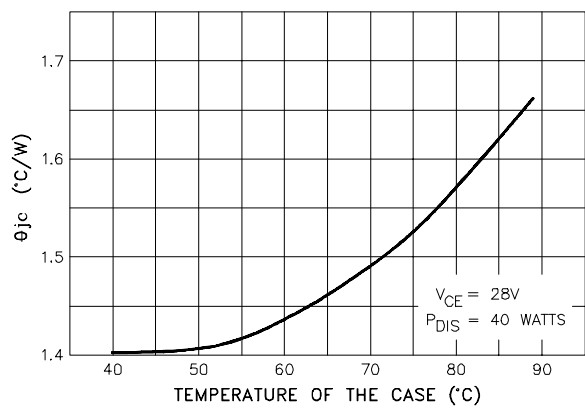

IMPEDANCE DATA

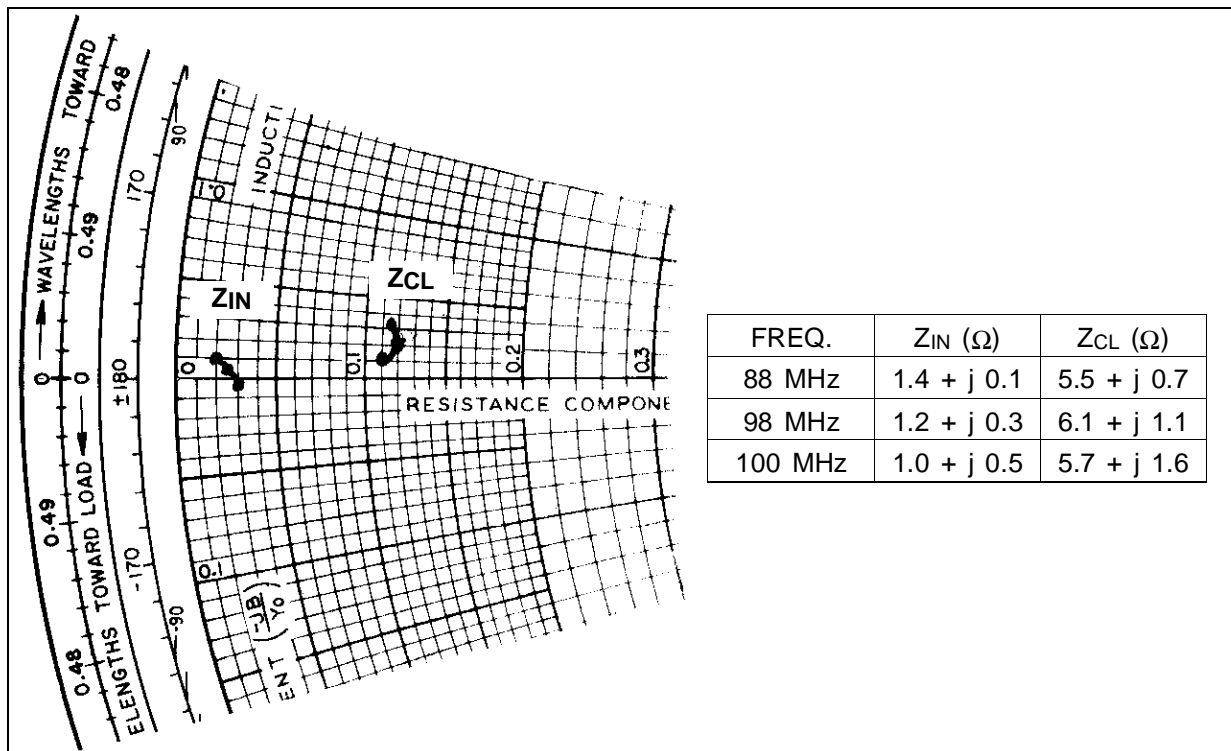

TEST CIRCUIT

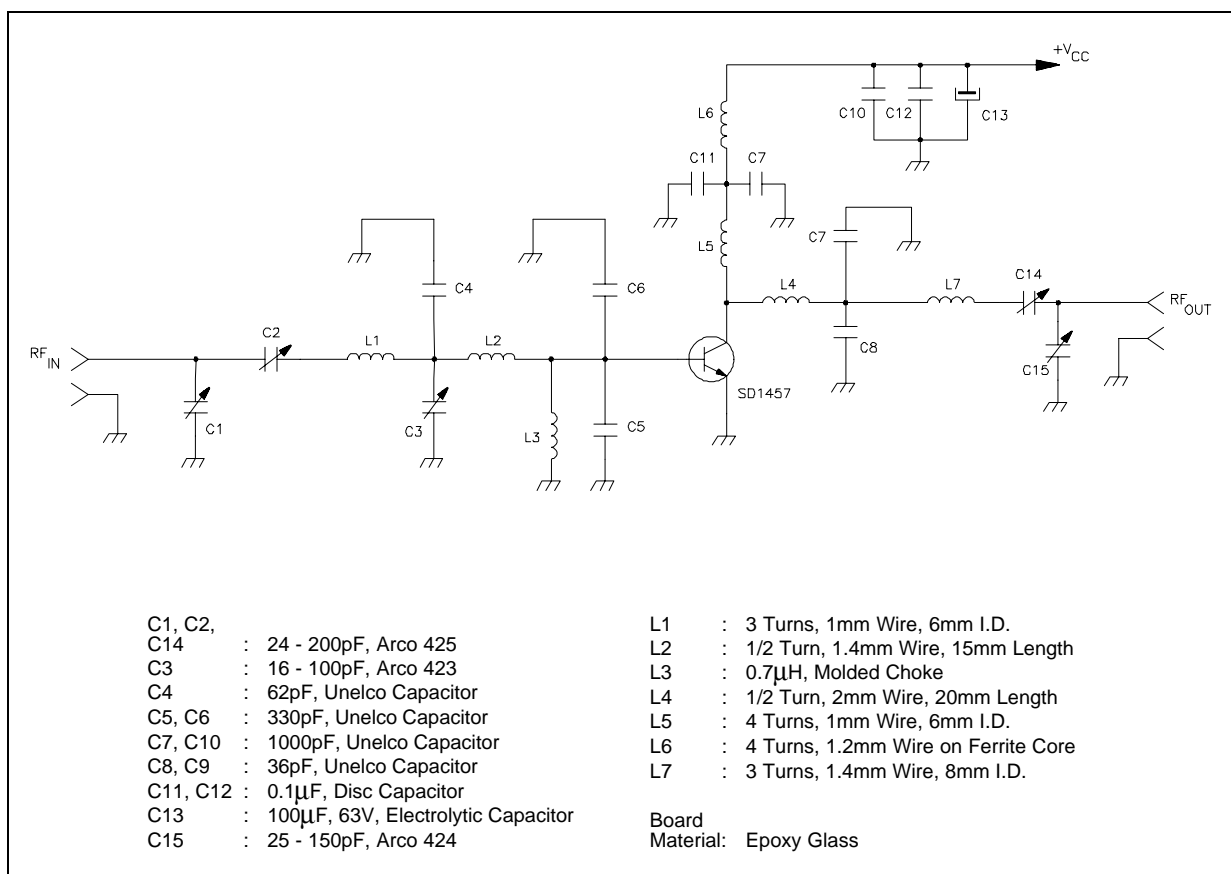

PACKAGE MECHANICAL DATA

Ref.: Dwg. No.12-0174

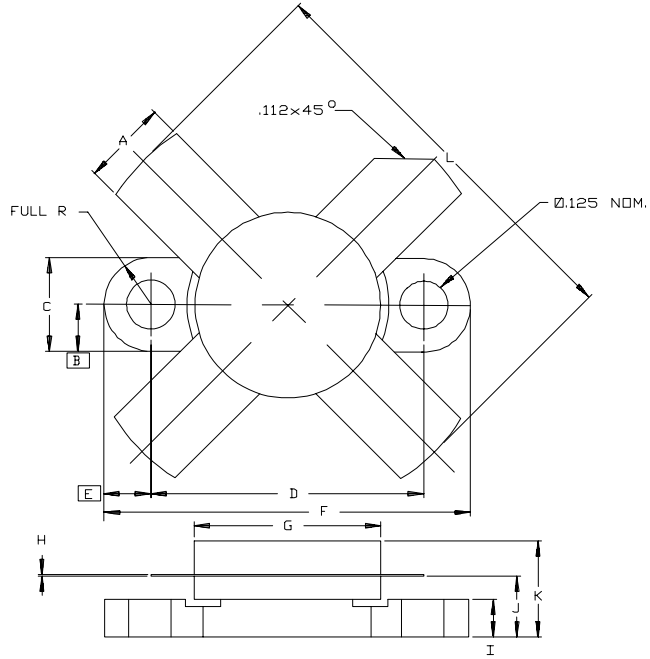

SGS-THOMSON MICROELECTRONICS			CONT'D		
	MINIMUM Inches/mm	MAXIMUM Inches/mm		MINIMUM Inches/mm	MAXIMUM Inches/mm
A	.220/5,59	.230/5,84	K		.280/7,11
B	.125/3,18		L		1.050/26,67
C	.245/6,22	.255/6,48			
D	.720/18,28	.730/18,54			
E	.125/3,18				
F	.970/24,64	.980/24,89			
G	.495/12,57	.505/12,83			
H	.003/0,08	.007/0,18			
I	.090/2,29	.110/2,79			
J	.160/4,06	.175/4,45			

Information furnished is believed to be accurate and reliable. However, SGS-THOMSON Microelectronics assumes no responsibility for the consequences of use of such information nor for any infringement of patents or other rights of third parties which may result from its use. No license is granted by implication or otherwise under any patent or patent rights of SGS-THOMSON Microelectronics. Specifications mentioned in this publication are subject to change without notice. This publication supersedes and replaces all information previously supplied. SGS-THOMSON Microelectronics products are not authorized for use as critical components in life support devices or systems without express written approval of SGS-THOMSON Microelectronics.

© 1994 SGS-THOMSON Microelectronics - All Rights Reserved

SGS-THOMSON Microelectronics GROUP OF COMPANIES
Australia - Brazil - France - Germany - Hong Kong - Italy - Japan - Korea - Malaysia - Malta - Morocco - The Netherlands -
Singapore - Spain - Sweden - Switzerland - Taiwan - Thailand - United Kingdom - U.S.A